

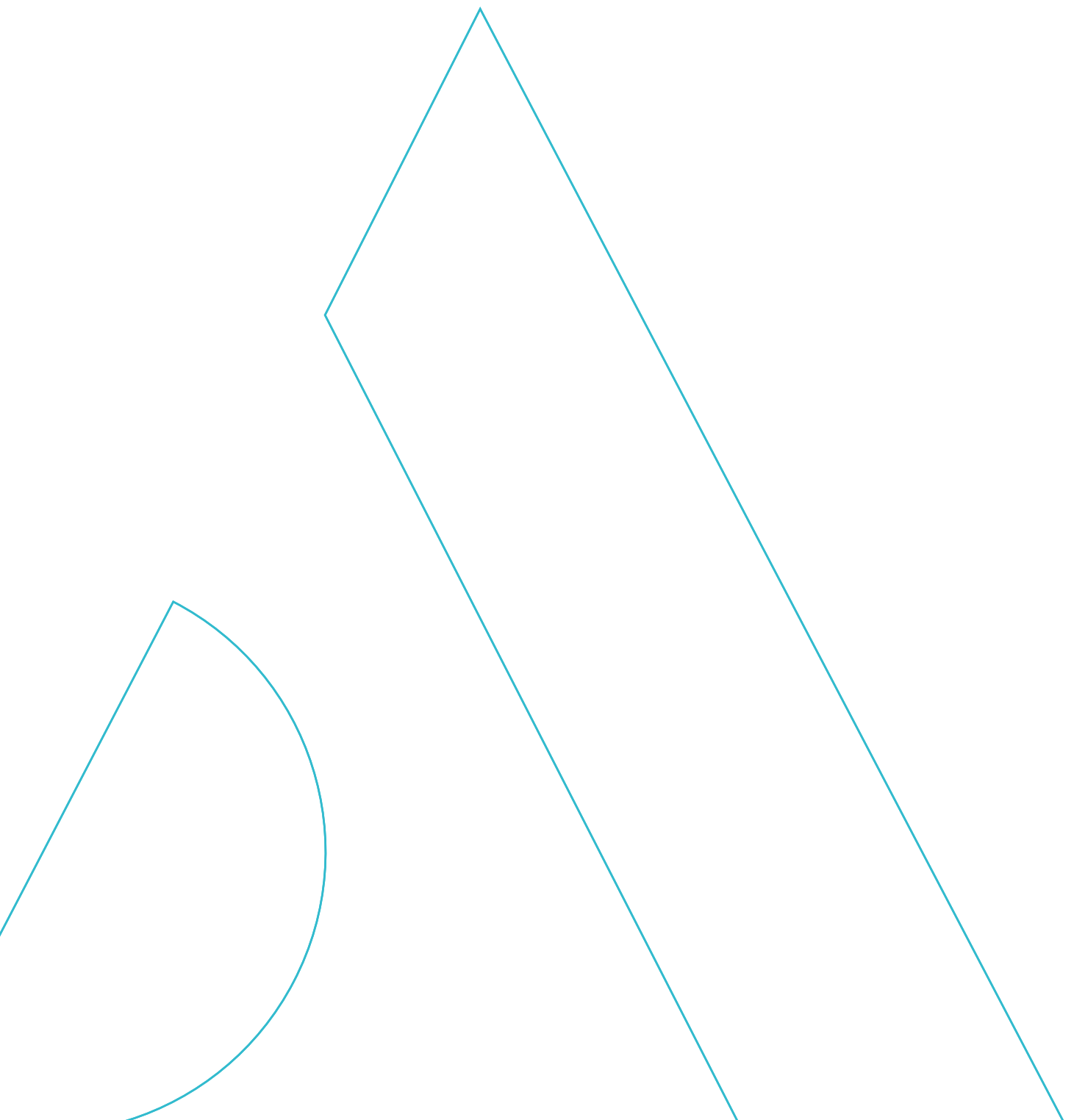

Surgical Technique



Summary

Introduction	4
Overview of the implant	5
Overview of the surgical technique	12
Step 1 Pre-operative planning	15
Step 2 Distal femoral resection	16
Step 3 Intra-medullary guide	19
Extra-medullary guide	20
Combined tibial guide	21
Step 4 Tibial resection	22
Step 5 Extension and flexion gaps	23
Step 6 Femoral resections	26
Step 7 Femoral preparation	28
Step 8 Positioning of the trial femoral component	30
Step 9 Tibial preparation	31
Step 10 Patella preparation : patellar resection option	33
Patella preparation : Patella reaming option	34
Step 11 Definitive implants	35
Step 12 Implant extraction	37
Instrumentation	39
Appendix A	51
Appendix B	52

Introduction

- This surgical technique relates to the ANATOMIC instrumentation and the 4-in-1 femoral resection instrumentation used to implant the ANATOMIC Total Knee System (TKS).
- Either the tibial cut or the distal femoral cut can be performed first.
- In the following surgical technique description, the distal femoral cut is performed first.
- The instrumentation can be used either:
 - without navigation (conventional method)
 - with navigation (by adding the Universal Knee Navigation Tools)
 - with the customised i.M.A.G.E. instrumentation (by adding the i.M.A.G.E. 4-in-1 tools).



Overview of the implant

- ▶ The ANATOMIC TKS is a PCL-sacrificing, posterior-stabilized, fixed bearing implant for primary knee arthroplasty.
- ▶ Its mediolateral coverage matches the morphology of the femur.
- ▶ Stability is provided:
 - in extension thanks to a congruent anterior lip,
 - in flexion thanks to a late contact between the cam and the post of the posterior stabilization mechanism.



Femoral component

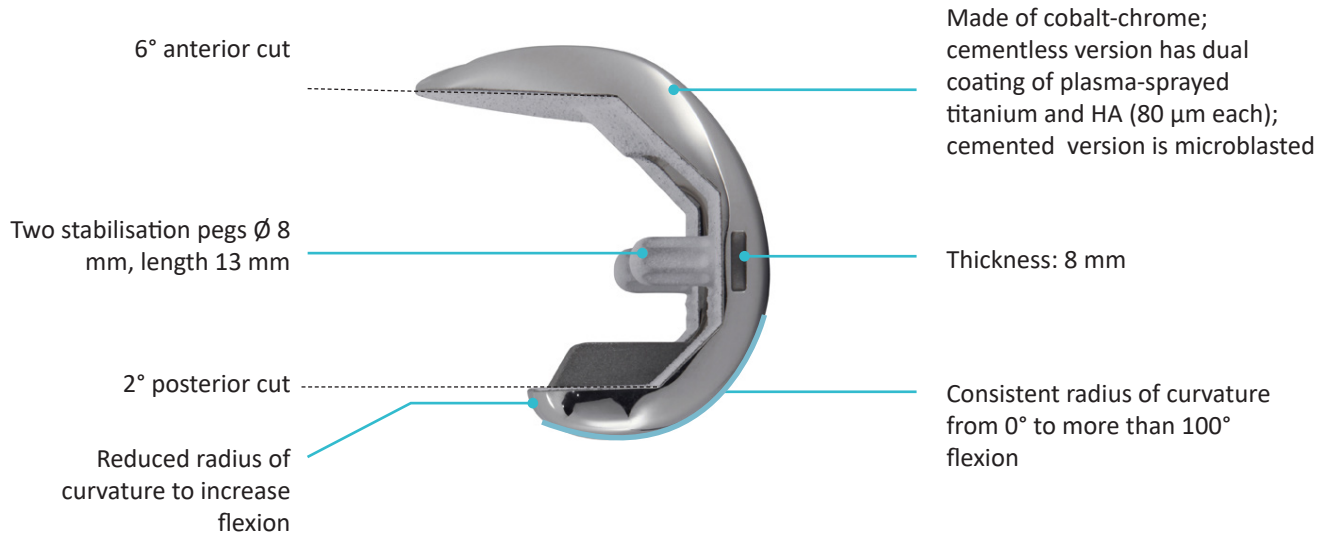

Trochlear groove lateralised by an average of 2.3 mm



Asymmetrical contact surfaces:
quasi-physiological joint kinematics



Post-cam contact beyond 90 flexion and up to 130° flexion

Patellar component

Polyethylene patellar implant available in two versions:

**Onset patellar implant—
cemented**

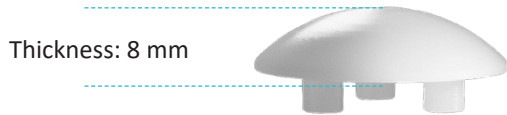

**Inset patellar implant—
cemented**



Tibial component

Tibial insert



Posterior post position: beneficial for flexion



Flat baseplate posteriorly
✓ Condyle rollback during flexion

Tibial component

Tibial baseplate

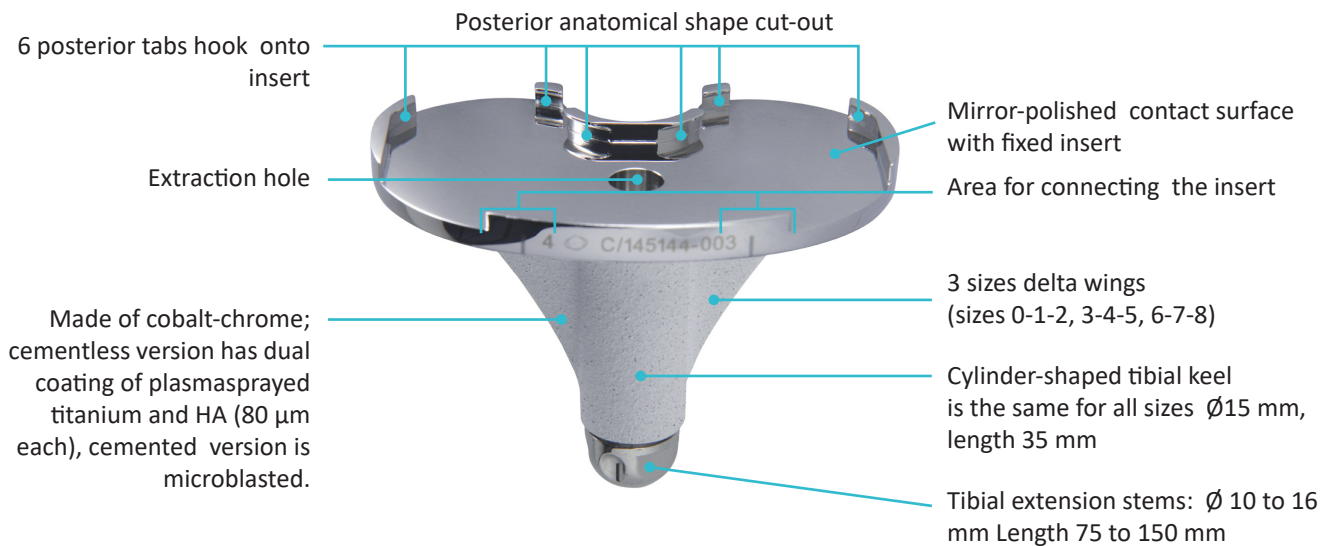

Possibility of using (e.g. in cases of UKA revision or TKA after osteotomy):

Tibial extension stems:

- Ø 10 to 16 mm
- Length 75 to 150 mm

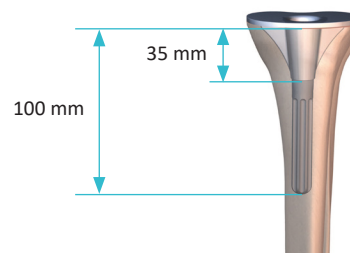

Example with a 100mm long extension stem

Length	Diameter			
75	10	12	14	
100	10	12	14	16
150	10	12	14	16

ANATOMIC tibial augments:

- Thickness 5 mm
- Thickness 10 mm
- Thickness 15 mm



Product range

Femoral components:

- Cemented: 9 sizes (0 and 8 are optional)
- Cementless: 9 sizes (0 and 8 are optional)

Mediolateral implant coverage matches bone morphology

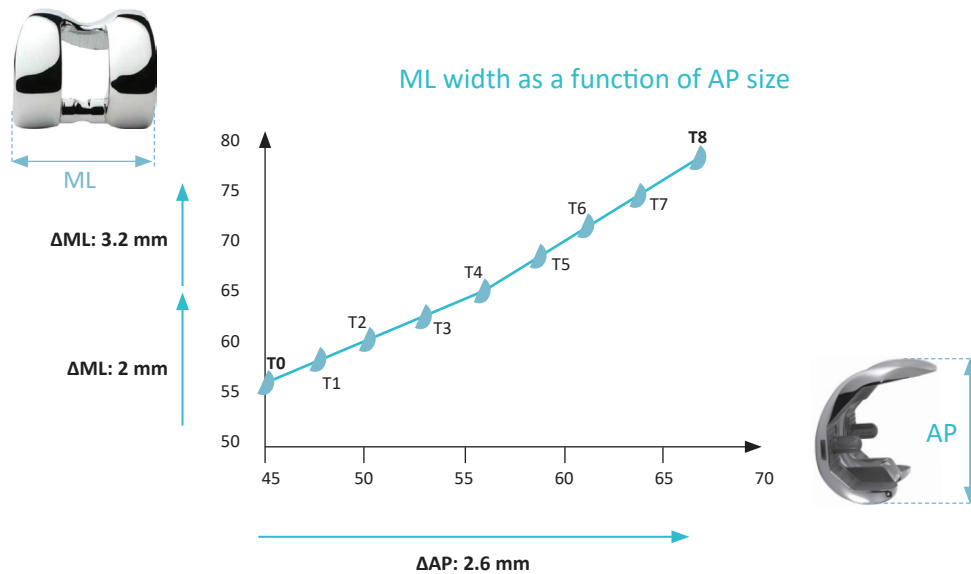

Patellar components:

- Onset patellar implant – cemented: \varnothing 30, 33 and 36 mm
- Inset patellar implant – cemented: \varnothing 23, 26 and 29 mm

Tibial components:

- Cemented: 9 sizes (0 and 8 are optional)
- Cementless: 9 sizes (0 and 8 are optional)

Inserts:

- 9 sizes (0 and 8 are optional)
- 6 thicknesses (10, 12, 14, 16, 18 & 20 mm)

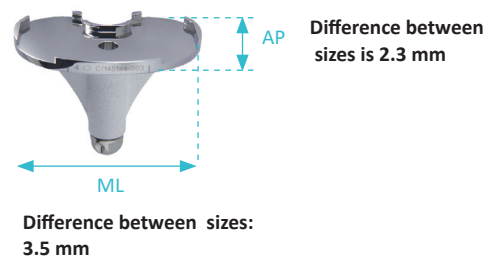

Components compatibility

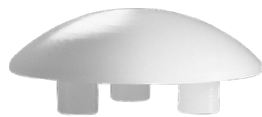
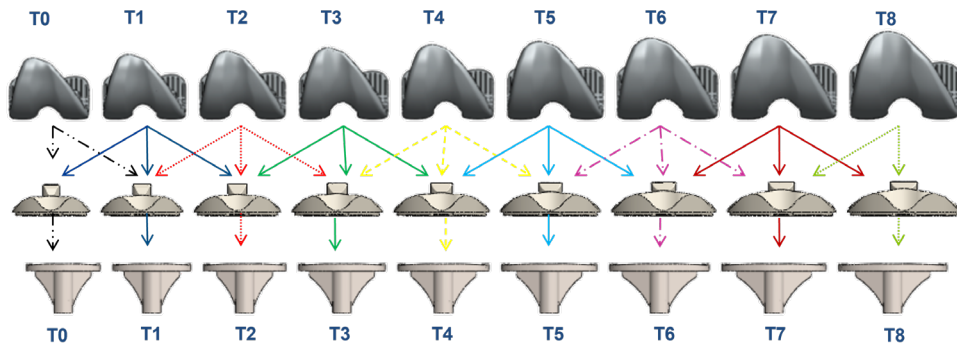

All sizes of cemented resurfacing patellar implants are compatible with all sizes of ANATOMIC posterior stabilized femoral components.

ANATOMIC femoral component size 7 and size 8 are not compatible with cemented inset patellar implant \varnothing 23 mm.



Overview of the surgical technique

1

Distal femoral cut

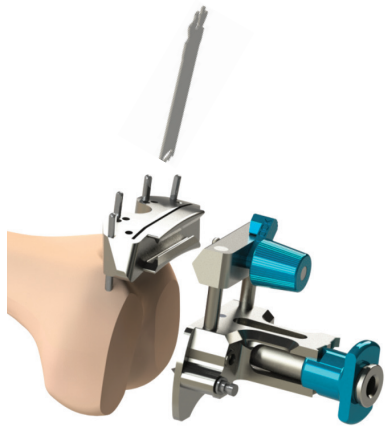

2

Intra-medullary tibial jig



3

Extra-medullary tibial jig



4

Tibial cut

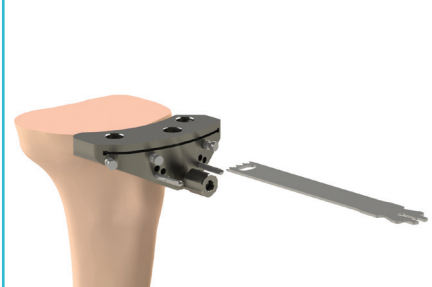

Overview of the surgical technique

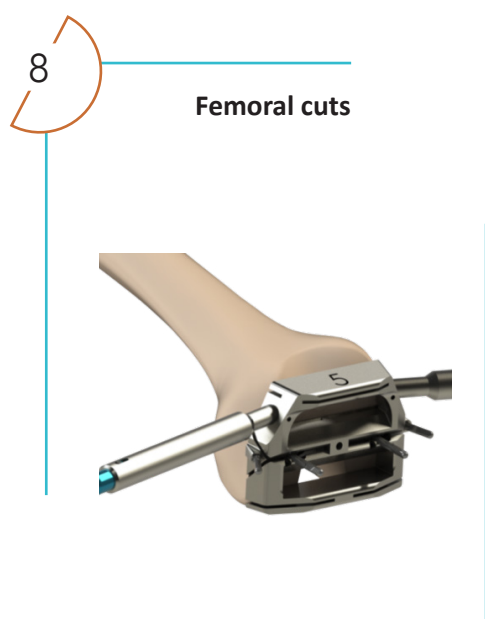
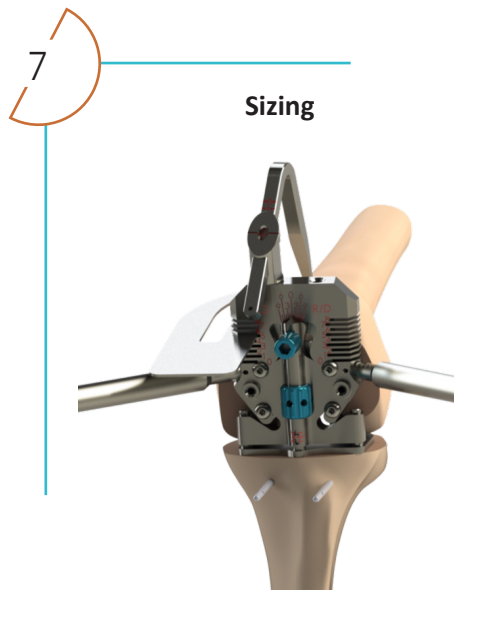
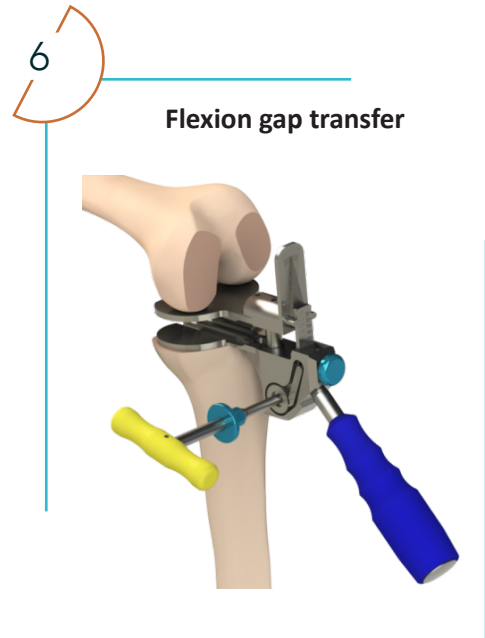
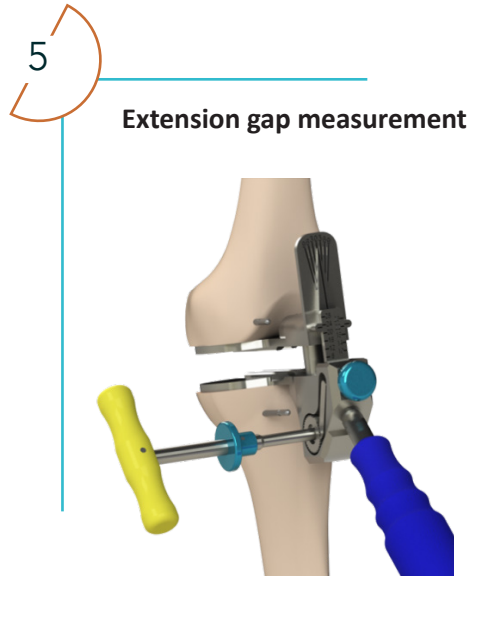

Overview of the surgical technique

9

Femoral preparation

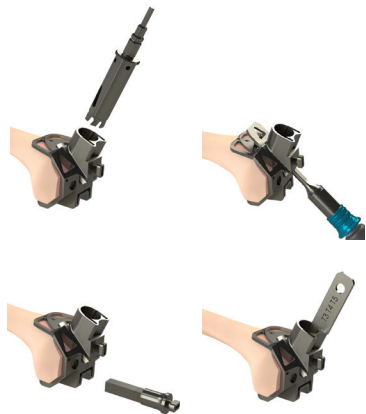

10

Tibial preparation



11

**Patella preparation
Resurfacing option**



12

**Patella preparation
Patellar reaming option**



1 Pre-operative planning

Using X rays and templates, you can determine concerning bone:

On the tibia:

- The choice between intramedullary and extramedullary aiming.
- The entry point of the intramedullary rod (coronal and sagittal view).
- The adaptation of the tibial stem to the metaphysis (in case of previous tibial osteotomy).
- The osteophytes.
- The severity of the compartment wear.
- The choice of an extension tibial stem, if required.
- The assessment of the baseplate size and the insert thickness.

On the femur:

- The entry point of the intramedullary rod (front and sideways).
- The anatomical femoral valgus angle.
- The posterior osteophytes.
- The size.

On the patella:

- The wear of the patellofemoral joint.
- The thickness, the width, the global shape, the tilt and the height of the patella.
- The thickness and the orientation of the patellar resection.
- The mediolateral position of the patellar implant.

NOTE

The provided templates have a 1:1 scale. Make sure the template scale matches the X-ray scale

REMINDER

This surgical technique describes how to use the instrumentation properly. The surgeon is fully responsible for choosing the surgical approach and technique

2 Distal femoral resection

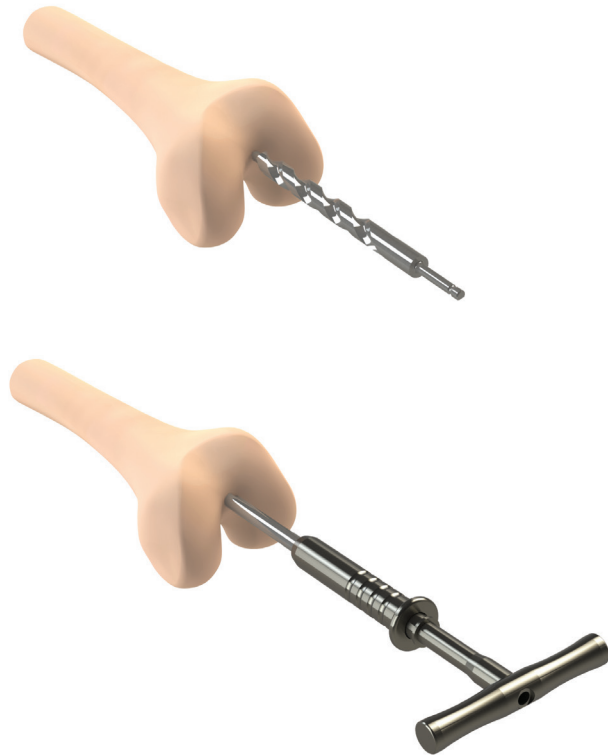

Intramedullary femoral alignment:

- Bend the knee at 90°
- Remove any peripheral osteophytes.
- Clear out tissues to access the anterior cortex.
- Based on the pre-operative planning, determine the entry point for the intramedullary (IM) canal and open it with the Intramedullary drill bit.
- Assemble the Intramedullary rod length 400 mm on the T wrench, and insert it into the canal. The landmark located on the Rod must always be visible.

NOTE

If the Intramedullary rod length 400 mm cannot be inserted or if there is a pre-existing THA, use the Intramedullary rod length 250 mm.

Position the Femoral Valgus Alignment Guide:

- Adjust the femoral valgus (3°, 5°, 7°, 9° or 11°) to match the femoral valgus measured during the pre-operative planning and place it on the operated leg (LEFT/ RIGHT).
- Place the Femoral Valgus Alignment Guide 0° (or 3° or 6°) on the Intramedullary rod.
- Make sure the barrel rests against a healthy portion of the distal condyle and confirm the femoral valgus reading.

Femoral Valgus Alignment Guide
(for right and left sides)

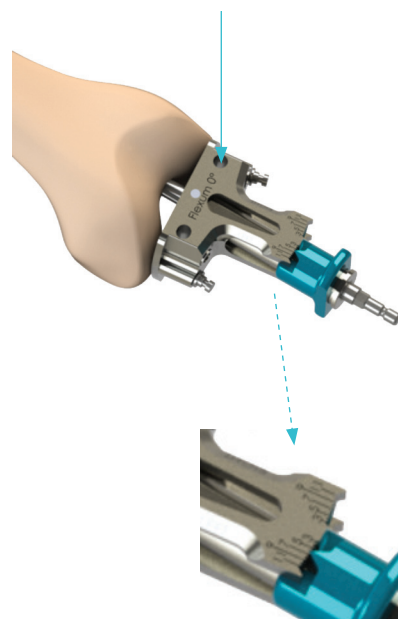

Distal Femoral resection

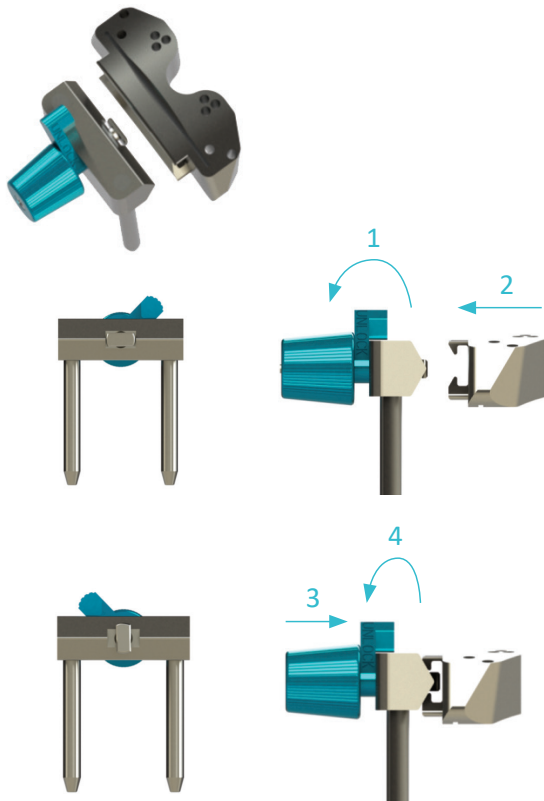

Assembly of the distal resection guide:

- Assemble the Distal Resection Guide 8 mm (or 10 mm) on the Distal slide bar and the Distal slide bar onto the Femoral Valgus Alignment Guide 0°.

1- Loosen the wheel on the Distal slide bar.

2- Make sure the upper lever is in the « unlock » position, join the Distal Resection Guide and the Distal slide bar together in a « V » by aligning the line on the resection guide with the one on the slide bar, the lines ensure that the two components are centred.

3- Press down on the wheel.

4- Turn the upper lever to the « lock » position to lock the two components in place.

Distal Resection Guide positioning:

- Place the Distal slide bar and Distal resection guide onto the Valgus Alignment Guide.
- Adjust the position of the Distal resection guide:
 - in the mediolateral direction (to prevent patellar impingement),
 - in the anteroposterior direction (Distal Resection Guide touches the bone).
- Fully tighten the thumb knob on the distal slide bar to lock the mediolateral position of the Distal Resection Guide.
- Use the Screwdriver H3.5 to secure the Valgus Alignment Guide to the Distal slide bar.

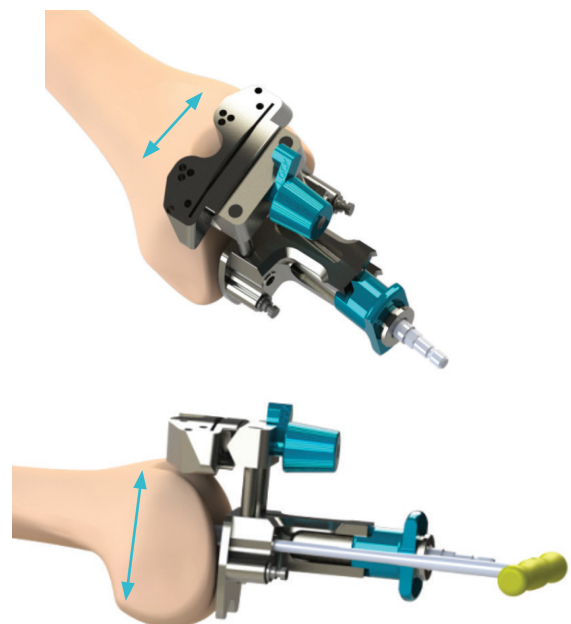

Distal femoral resection

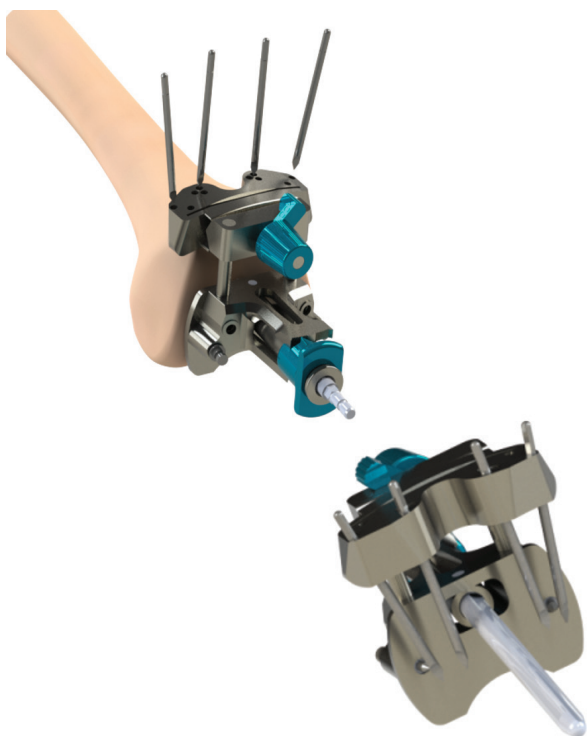

Pin insertion:

- Use the Universal quick release adaptor for pin or the Pin Driver AO assembled on a Surgical Power Reamer to insert two Headless pins length 80 mm into the 0 holes.

NOTE

On patients with flexion deformity, the distal cut (initially 8 mm) can be increased by switching the guide in order to have the pins into the +2 or +4 holes.

- Use two other similar pins inserted in the oblic holes to stabilise the Distal resection Guide.

Distal cut:

- Remove the Intramedullary rod using the T wrench.
- Loosen the thumb knob on the distal slide bar by moving the upper lever to the « unlock » position and detach the entire Distal Resection Guide.
- Check the cut thickness with the Resection gauge.
- Perform the distal cut using a medium AMPLITUDE saw blade.
- Extract the oblic pins with the handpiece or with the Pin extractor.
- Slide the Distal Resection Guide off the pins in the 0 holes, but leave the pins in place in case recutting is necessary.
- If the Tibial resection is achieved first, the Alignment gauge can be place on the tibial resection to protect the bone.

NOTE

Depending on the bone quality, Long Drill bit, \varnothing 3.2, length 145 mm can be used to prepare the holes for the pins.

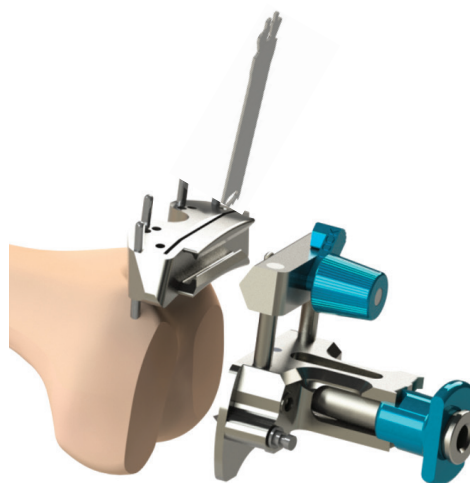

3 Intra-medullary guide

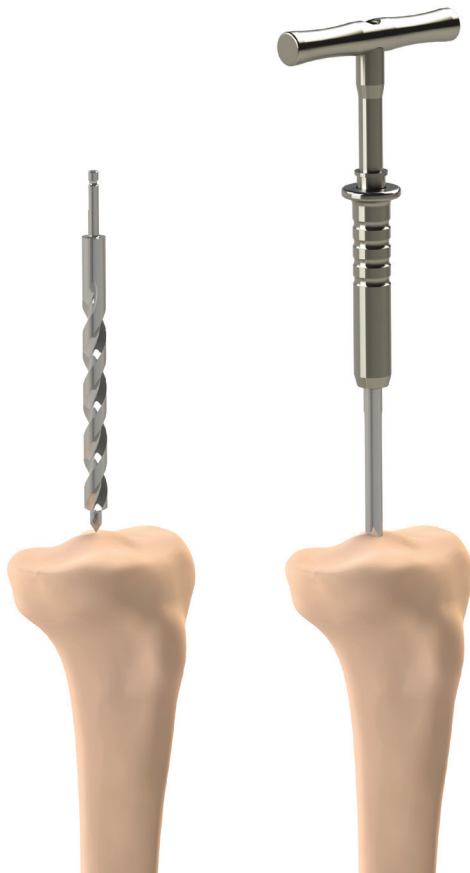

Intramedullary tibial alignment:

- Based on the pre-operative planning, determine the entry point for the intramedullary (IM) canal and open it with the Intramedullary drill bit.
- Assemble the Intramedullary rod length 400 mm on the T wrench and insert it into the canal, the landmark must always be visible.

NOTE

If the Intramedullary rod length 400 mm cannot be inserted use the Intramedullary rod length 250 mm.

Assembly of the Intramedullary System:

- Attach the Tibial slide bar and the Tibial resection guide (left or right) together onto the Tibial bracket. Tighten the Wheel for resection guide and the Wheel for tibial bracket with the H5 Screwdriver or by hand.
- Insert this entire unit onto the Intramedullary rod, adjust its rotation relative to the anterior tibial tuberosity and then impact the tabs.
- Clip the Tibial stylus onto the Tibial resection guide (make sure the clip is fully engaged).
- Set the resection height by using the Tibial stylus to palpate either the:
 - healthy side (10 mm cut relative to the chosen point),
 - worn side (0 mm cut relative to the chosen point (exit level of the saw blade)).
- For other resection heights, use the 2 mm markings on the Tibial slide bar.
- Verify the height of the bone cut with the Resection gauge.

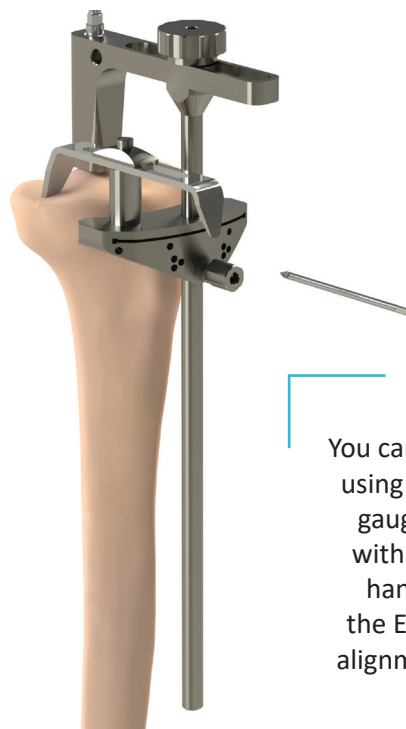

NOTE

You can check the axis using the Alignment gauge assembled with the Universal handle in which the Extramedullary alignment rod slides.

Extra-medullary guide



Assembly of the Extramedullary System and resection adjustment:

- Attach the Tibial slide bar and the Tibial resection guide (left or right) together onto the Tibial bracket. Tighten the Wheel for resection guide and the Wheel for tibial bracket with the H5 Screwdriver or by hand.
- Assemble the Malleolar clamp with the Extramedullary alignment guide and with the Tibial slide bar.
- Place the Malleolar clamp around the ankle, and then place the Tibial bracket on the intercondylar eminence.
- Tightened the Wheel for extramedullary Alignment column.
- Set the rotational and sagittal alignments before impacting the tabs.
- Clip the Tibial stylus onto the Tibial resection guide (make sure the clip is fully engaged).
- Set the resection height by using the Tibial stylus to palpate either the:
 - healthy side (10 mm cut relative to the chosen point),
 - worn side (0 mm cut relative to the chosen point (exit level of the saw blade)).
- For other resection heights, use the 2 mm markings on the Tibial slide bar.
- Check the bone cut height with the Resection gauge.

NOTE

You can check the axis using the Alignment gauge assembled with the Universal handle in which the Extramedullary alignment rod slides.

NOTE

The H5 Screwdriver can be used to tighten all the wheels of the tibial jig.

Combined tibial guide



Landmarks:

- See page 19

Assembly of the Combined System and resection height adjustment:

- Attach the Tibial slide bar and the Tibial resection guide (left or right) together onto the Tibial bracket. Tighten the Wheel for tibial bracket.
- Assemble the Malleolar clamp with the Extramedullary alignment guide and with the Tibial slide bar.
- Place the Malleolar clamp around the ankle and then place the Tibial bracket onto the intercondylar eminence.
- Set the rotational and sagittal alignments before impacting the tabs.
- Clip the Tibial stylus onto the Tibial resection guide (make sure the clip is fully engaged).
- Set the resection height by using the Tibial stylus to palpate either the:
 - healthy side (10 mm cut relative to the chosen point),
 - worn side (0 mm cut relative to the chosen point (exit level of the saw blade)).
- For other resection heights, use the 2 mm markings on the Tibial slide bar.
- Check the bone cut height with the Resection gauge.

NOTE

You can check the axis using the Alignment gauge assembled with the Universal handle in which the Extramedullary alignment rod slides.

NOTE

The H5 Screwdriver can be used to tighten all the wheels of the tibial jig.

4 Tibial resection

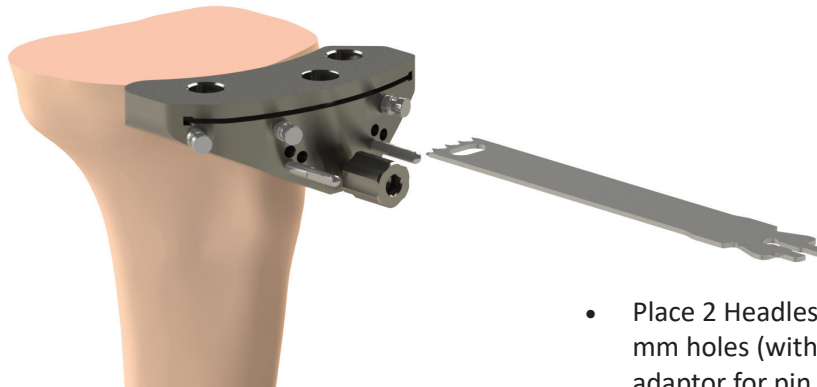

NOTE

Depending on the bone quality, Long Drill bit $\varnothing 3.2$, length 145 mm can be used to prepare the holes for the pins.

- Place 2 Headless pins length 80 mm in the 0 mm holes (with the Universal quick release adaptor for pin or the Pin Driver AO).
- The +2 and +4 markers will be used if a tibial recut is required.
- Place the « T » end of the Slap hammer into the opening on the Tibial bracket and then remove the entire intra- or extramedullary assembly.
- Place the Tibial resection guide flush with the anterior tibial cortex.
- Insert 3 Headed pins length 70 mm (or the Collared threaded pins $\varnothing 3.2$ -L57) to stabilize the Tibial resection guide.
- Perform the tibial cut.
- Remove the Headed pins with the Pin extractor.
- Slide the Tibial resection guide off the Headless pins, by leaving the pins in place in case a recut was necessary (the +2 and +4 holes will be used at that time).
- The Flat rasp can be used to flatten the tibial resection.

5 Extension and flexion gaps

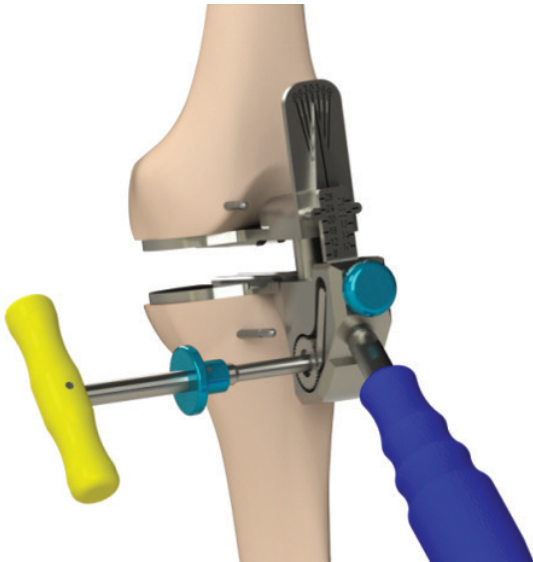

Extension gap measurement:

This step is carried out after performing the distal femoral and tibial cuts. The goal is to achieve a rectangular gap in extension when the ligaments are under tension. The resulting gap will be measured and should be the same when the knee is flexed.

- Insert the Extra-articular ligament balancer V2 into the knee joint with the knee extended.
- Insert the Snap Screwdriver H5 into the balancer's cog wheel.
- Turn the Snap screwdriver H5 to operate the distraction mechanism and apply the desired amount of tension. Do not apply excessive distraction, otherwise the knee will flex. The knee must stay extended during the measurements.
- Make sure the tibial and distal femoral cuts are parallel, and check the height of the tibiofemoral gap.
- If the tibiofemoral gap is less than the 18 mm minimum gap needed (10 mm for the tibial component plus 8 mm for the femoral component), redo the tibial or distal femoral cut.

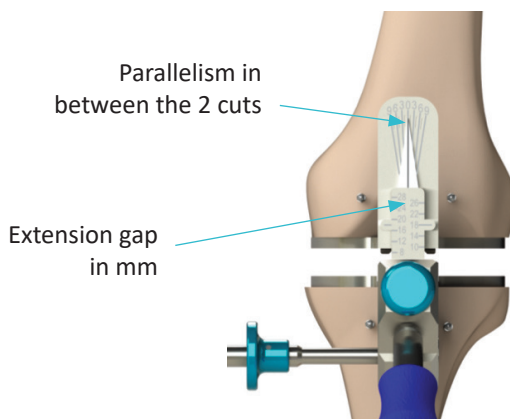

Minimum gap in extension :
 $18 \text{ mm} = 10 \text{ mm (tibial component)} + 8 \text{ mm (femoral component)}$

NOTE

Ligament can be released to achieve desired ligament balance (value of 0 on Balancer).

Extension and flexion gaps

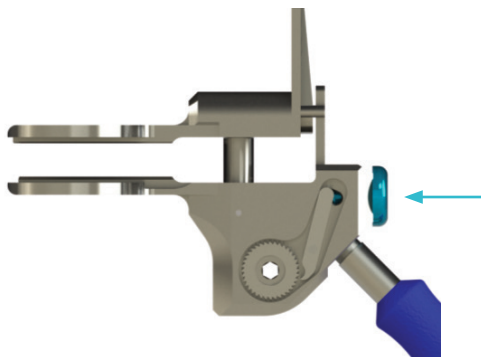

- Press the blue unlock button to remove the Extra-articular ligament balancer V2 from the joint.

REMARQUE

Remove the 2 Headless pins length 80 mm left in anterior part.

Flexion gap measurement:

- Flex the knee.
- Insert the Extra-articular ligament balancer V2 and apply the desired tension (same procedure as with knee extended).
- Read the flexion gap value and femur rotation value (induced by ligament laxity) relative to the tibia.
- Make sure the flexion gap is equal to the extension gap (8 mm must be subtracted from the extension gap value).

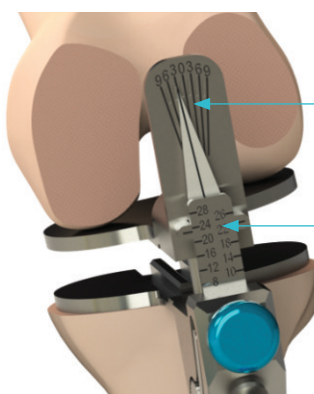

Femoral rotation in degree

Read flexion gap here (subtract 8 mm from extension gap)

Option: Spacer technique:

- Spacers can be used to check the ligament balancing.
- In extension: assemble the Spacer thickness 18 mm on the Universal handle. Apply a slight varus and valgus forced to check the balance. If it's too loose, it is possible to add a Spacers thickness 2 mm or 4 mm for spacer.
- In Flexion: assemble the Spacer thickness 10 mm on the Universal handle. Apply a slight varus and valgus forced to check the balance. If it's too loose, it is possible to add a Spacers thickness 2 mm or 4 mm for spacer.
- Make sure the flexion gap is equal to the extension gap (8 mm must be subtracted from the extension gap value).

Extension and flexion gaps

Transfer of gap into flexion:

On table

- On the 4-in-1 pin positioner, set the femoral rotation based on the measurement taken with the Extra-articular ligament balancer V2.
- If the flexion gap is equal to the extension gap, set the posterior plate position to 0 mm.
- If the flexion gap is larger than the extension gap, set the posterior plate position to -2 mm to reduce the posterior gap by 2 mm.
- If the flexion gap is smaller than the extension gap, set the posterior plate position to +2 mm to increase the posterior gap by 2 mm.
- Insert the 4-in-1 probe.

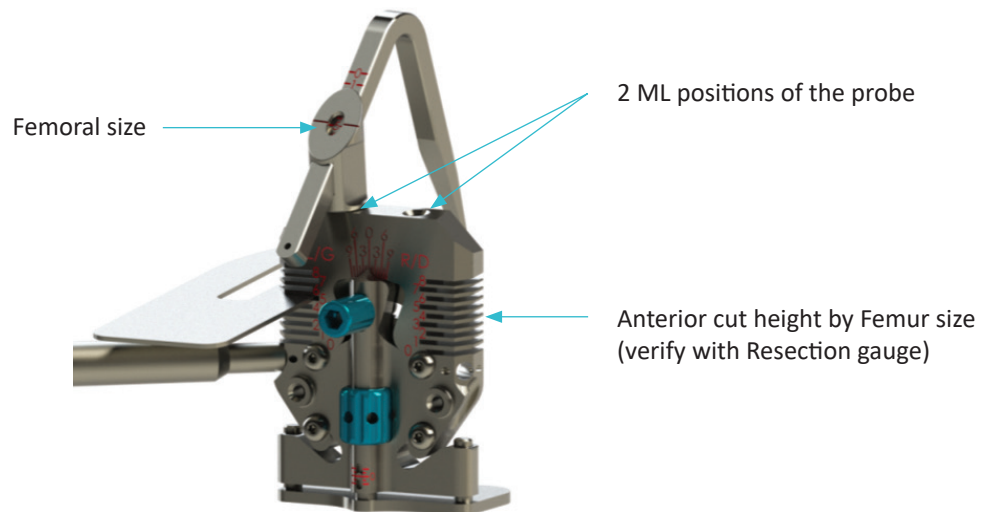

NOTE

The 4-in-1 pin positioner uses a posterior reference.

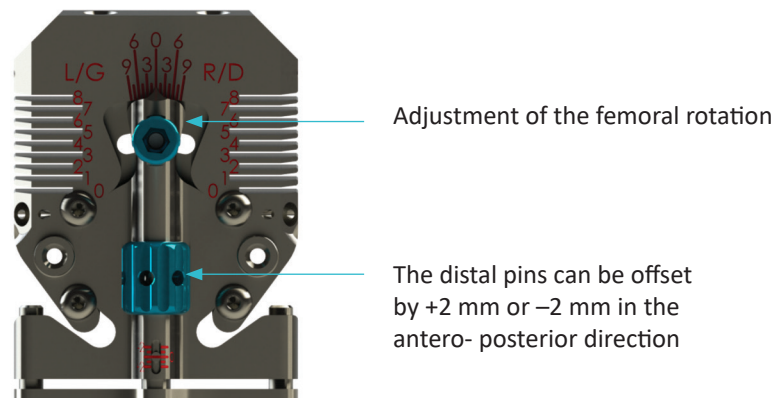

6 Femoral resection

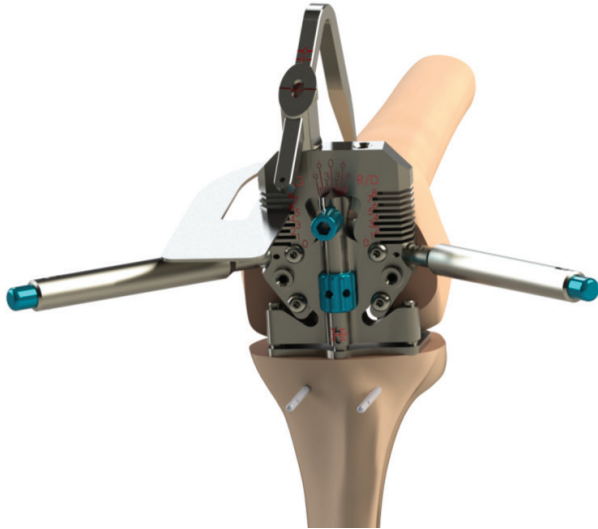

Distal Pin insertion:

On patients

- Remove the Extra-articular ligament balancer V2 and place the 4-in-1 pin positioner while making sure:
 - it is flush with the distal cut and
 - it rests against the posterior condyles
- Place the 4-in-1 probe tip against the anterior cortex and determine the femoral component size.
- Verify the size by placing the Resection gauge into the slots to preview the anterior cut position.
- It is possible to insert an Alignment Pin \varnothing 2 Length 150 mm on each side of the 4-in-1 pin positioner in order to check the femoral rotation.
- If the femoral size shown is between 2 sizes, the distal pins can be offset:
 - **position + 2 mm:** femoral component position will be offset by 2 mm anteriorly (posterior gap is 2 mm larger, anterior cut is 2 mm higher).
 - **position - 2 mm:** femoral component position will be offset by 2 mm posteriorly (posterior gap is 2 mm smaller, anterior cut is 2 mm lower)
- Insert the two Headless pins \varnothing 3.2 Length 65 mm.
- Remove the 4-in-1 pin positioner.

Femoral resections



Femoral cuts:

- Set the 4-in-1 femoral resection guide that corresponds to the measured size on the distal pins in the central holes (neutral position).
- Make sure side of the 4-in-1 resection guide is flush with the distal cut.
- Use the Resection gauge to check the anterior cut will not notch the femoral cortex.
- If the femoral cuts need to be adjusted in the anteroposterior direction, set the 4-in-1 resection guide on the distal pins in either the lower holes (flexion gap increased by +1mm) or the upper holes (flexion gap decreased by -1 mm).

- Secure the 4-in-1 resection guide with Headless pins length 80 mm or with Collared threaded pins Ø3,2-L57.
- In patients with osteoporosis, better fixation can be achieved by adding a pin in the intercondylar notch, connect the two Removable hand holds on the 4-in-1 resection guide for better hold while inserting the pins.
- Make the anterior and posterior cuts using a medium AMPLITUDE saw blade that matches the instrumentation set and motorized handpiece.
- Remove the distal pins using the Pin extractor.
- Make the 2 chamfer cuts.

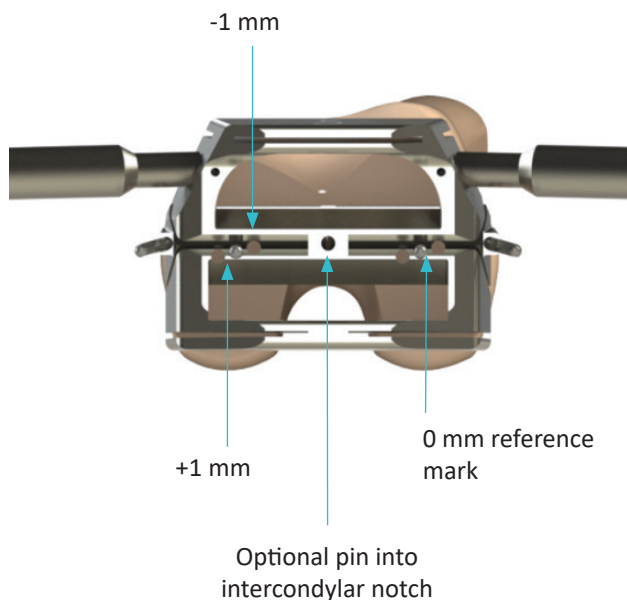

7 Femoral preparation

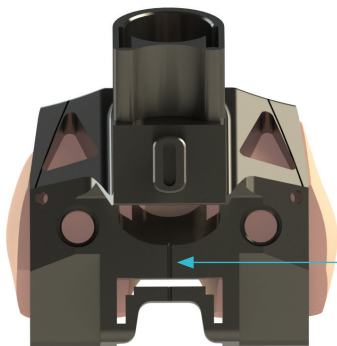
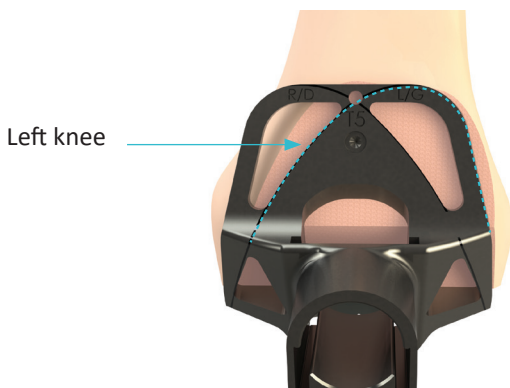
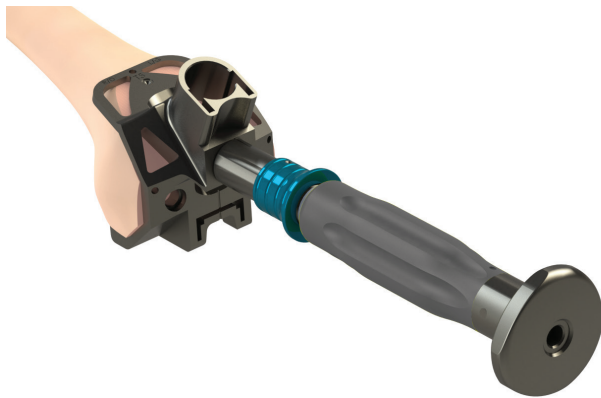

Femoral preparation guide placement:

- Choose the same size of Femoral preparation guide as the 4-in-1 resection guide used previously.
- Place the Universal handle on the oval clip by simultaneously pushing and turning the handle one-quarter turn.
- Place the Femoral preparation guide onto the femur. This guide has the same mediolateral dimensions as the final femoral component. Use the two windows on the anterior face to help position the guide:
 - the outer (lateral) side of the guide corresponds to the outer edge of the final femoral component
 - the inner (medial) side of the window corresponds to the inner edge of the final femoral component (see figure)
- The Femoral preparation guide can be centred in the medio-lateral direction by aligning the line at the centre of the guide over the posterior intercondylar notch.
- Secure the Femoral preparation guide with 3 Headed pins length 30 mm.
- Remove the Universal handle.

Femoral notch preparation:

- Select the same size of Notch reamer as the Femoral preparation guide.
- Push the Notch reamer into the Femoral preparation guide until it stops.

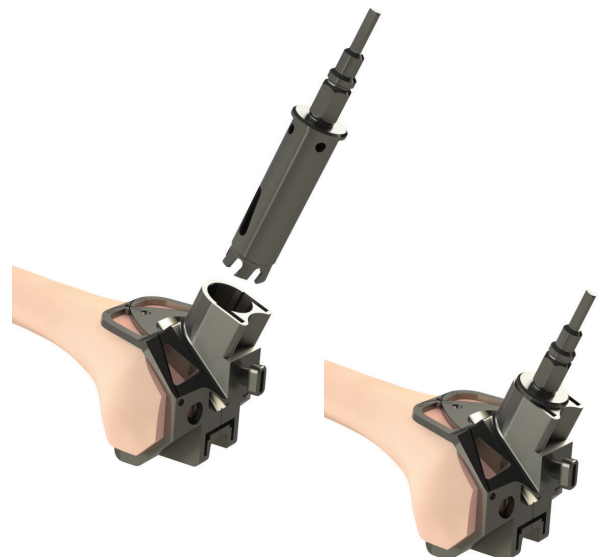

Femoral preparation



Femoral trochlea preparation:

- Select the Trochlea box chisel corresponding to the operated side and assemble it with the Universal handle.
- Prepare the trochlea by inserting the Trochlea box chisel into the Femoral preparation guide.

NOTE

Make sure the Trochlea box chisel is properly oriented from bottom to top.

Postero-stabilisation cam preparation:

- Assemble the L-shape chisel with the Universal handle.
- Prepare the posterior stabilization cam space by pushing the L-shape chisel into each side of the guide area. Impact the L-shape chisel until it reaches the line corresponding to the size of the Femoral preparation guide being used (guide entrance).
- Prepare the two holes for the pegs with the Drill for peg holes with stop.

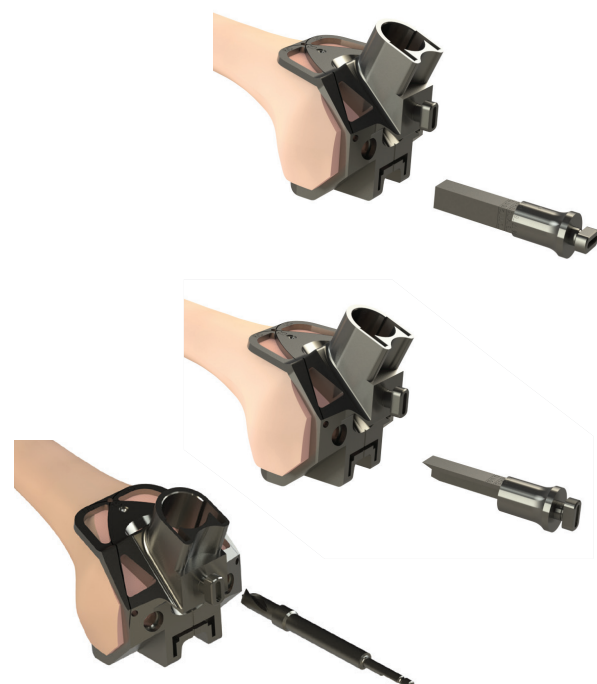



Final femoral preparation:

- To remove the bone ridge between the distal cut and reamed notch:
 - Select an Osteotome of the same size as the Femoral preparation guide
 - Push the Osteotome into each of the two slots on the outside of the reamer hole until it stops, make sure the « NOTCH SIDE » label faces the notch when pushing in the Osteotome
- Remove the 3 headed pins length 30 mm using the Pin extractor and extract the Femoral preparation guide using the Universal handle.

NOTE

If the Osteotome is difficult to pull out, place the T end of the Slap hammer into the hole.

8

Positioning of the trial femoral Component

- Select the appropriate side and size of the ANATOMIC Trial femoral component posterior stabilized.
- Set up the 2 Trial pegs for trial femoral component on the trial femoral component, and assemble it on the Femoral component Holder.
- Impact the trial femoral component adjusting the medio-lateral position as needed.
- Finish impacting the trial femoral component using the Femoral component impactor on the Universal handle.
- Any posterior osteophytes can be removed using the Cutting gauge or Unicompartmental osteotome.

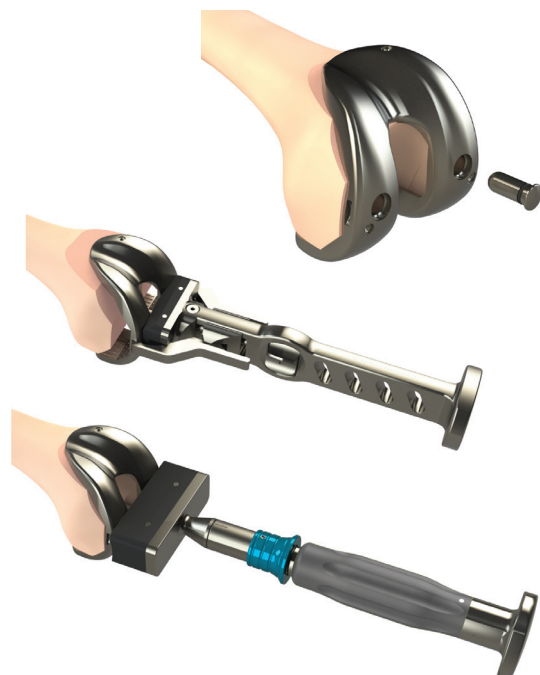

9 Tibial preparation



Placement of trial tibial baseplate:

- Determine the size of the ANATOMIC Trial baseplate posterior stabilized. The tibial baseplate can be the same, or one size larger or smaller than the size of the femoral component.
- Position the trial tibial baseplate onto the tibial cut. The Tibial baseplate handle can be used.
- Once the size has been selected, remove the Tibial baseplate handle, place the same size of ANATOMIC Trial fixed bearing insert, PS and reattach the Tibial baseplate handle. The lugs on the handle help secure the trial insert to the trial baseplate. In addition, the handle can be used with an Extramedullary alignment rod to verify the rotation, slope and perpendicular alignment of the tibial cut.

NOTE

Remove the 2 headless pins length 80 mm left in the tibia.

Trials:

- Put the assembled femoral and tibial trial components through a flexion / extension cycle to assess joint balance and allow the trial baseplate to seat itself in the appropriate rotation (the Tibial baseplate handle can be removed).
- Pick a different trial insert height if needed.
- Use electrocautery to mark the trial baseplate position on the tibia using the two lines on the trial baseplate.
- Remove the assembled tibial trial components and replace the baseplate (without the trial insert) using the marks made on the tibia as a guide.
- Secure the trial baseplate with two Headed pins length 30 mm.



Tibial preparation

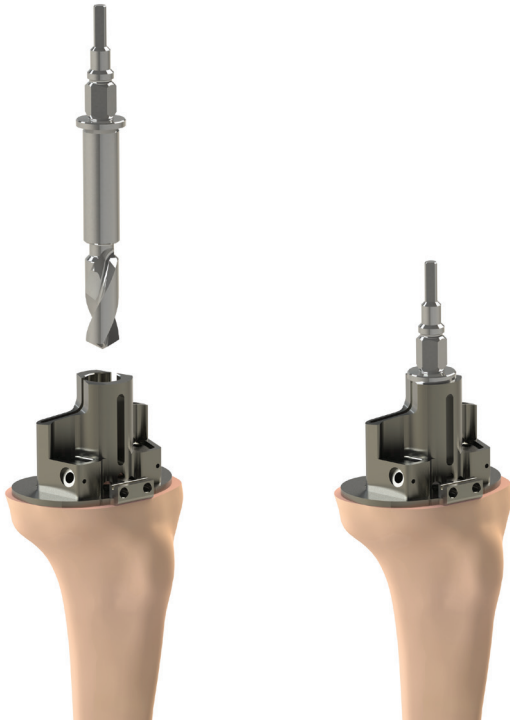

Keel preparation:

- Place the Guide for tibial fin punch onto the trial baseplate and verify that the sizes are compatible.
- Removable hand holds can be secured to the sides of the Guide for tibial fin punch to stabilise the entire assembly.
- With the power tool, drive the Reamer for tibial keel into the guide until it stops.

Fins preparation:

- Prepare the fins by pushing the appropriate size of the Tibial fin punch (assembled with the Universal handle) until it stops.
- Remove all the instruments using the Tibial baseplate handle and the Pin extractor.



10 Patella preparation: patellar resection option



Patellar preparation:

- Clear osteophytes.

Position the patellar Resection Clamp:

- Place the Patellar Resection Clamp, the two lugs are on the anterior side of the patella.
- With the clamp jaws open, bring the Patellar resection gauge in contact with the articular surface using the adjustment knob.
- Lock the clamp.
- Evaluate remaining bone.
- Push the saw blade into the slot to perform the cut.

Patellar preparation:

- Use the Patellar Drilling Guide Ø30 or Ø33 and Ø36 to determine the size of patellar component needed. It is recommended to use the size that allows maximum bone coverage, without presenting a prosthetic overhang.
- Centre and impact the Patellar Drilling Guide.
- Make the 3 holes for the pegs with the Drill Bit for Resurfacing Patella.
- Place the Trial resurfacing patella of the same diameter using the Clamp for Locking Ring.
- Test the articulation in the trochlea.

Patellar implantation:

- Clean and dry the bone surface.
- Apply cement onto the implant.
- Position the implant on the cut.
- Tighten the implant using the Patellar Impaction clamp.
- Remove the excess of cement.
- Keep the clamp until the cement is dry.

NOTE

The thickness of the patellar implant is 8 mm for all the diameters and it is advisable to leave a remnant of 12 mm of residual bone.

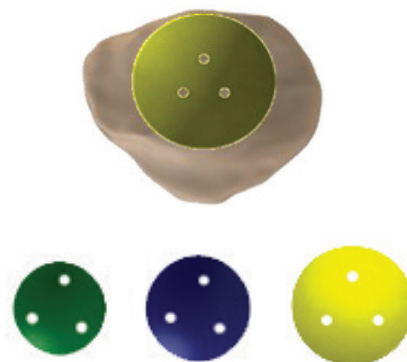

Patella preparation : reaming option



Patellar preparation:

- Clear osteophytes.

Position the Patella Reamer Clamp:

- Centre the Trial inset patellar - cemented \varnothing 23 mm – Plastic (or \varnothing 26, or \varnothing 29) on the articular surface of the native patella by centering it on the patellar crest.
- The appropriate size (\varnothing 23, 26 or 29 mm) is determined based on the following criteria:
 - Superior-to-inferior length of the articular surface
 - Width of the patella's medial articular facet
- The size must be as large as possible being slightly smaller (by about 2 mm) than the superior-to-inferior length of the articular surface and must be slightly inside the medial edge of the medial articular facet.
- Assemble the Patella Reamer Surfacing Guide corresponding to the chosen patellar implant size onto the Patella Reamer Clamp and lock it.
- Position the clamp. The inferior jaw on the Patella Reamer Clamp must rest against the anterior side of the patella. The clamp must rest against at least one of the patella's two articular facets.
- Use the thumb knob to tighten the Patella Reamer Clamp.
- Assemble the Reamer for inset cementless patellar of the same size as the chosen clamp onto the power tool.
- Ream the patella until the stop is reached.

Trials:

- Assemble the Patellar Reamer Impaction Clamp onto the Patella Reamer Clamp and lock it.
- Use it to place the Trial inset patellar - cemented — Plastic of the selected size into the native patella.
- Test the patella tracking.

Patellar implantation:

- Clean and dry the bone surface.
- Use the Patellar Reamer Impaction Clamp assemble on the Patella Reamer Clamp to insert the chosen patellar component.

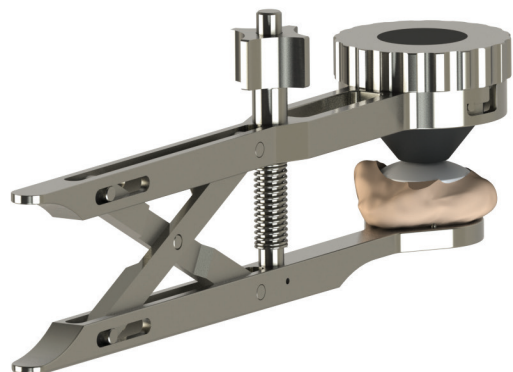

11 Definitive implants

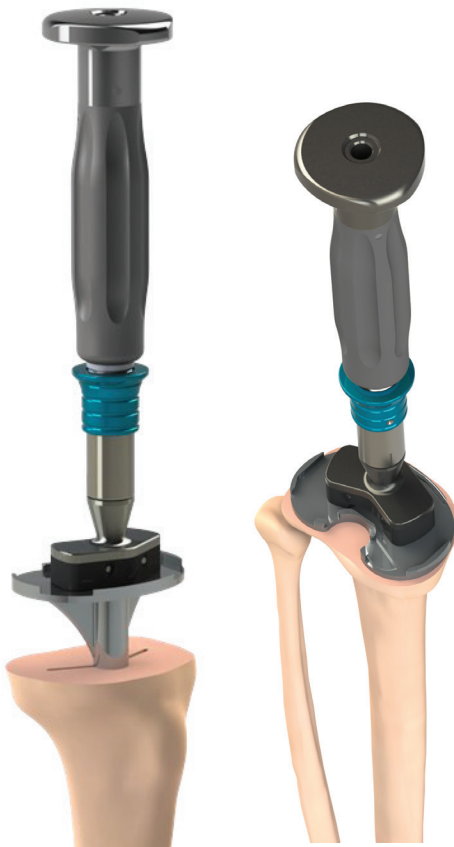

Insertion of chosen tibial baseplate:

- Use the Tibial stem wrench to screw the distal peg into the tibial baseplate (cemented or cementless).
- Wash and dry bone surfaces and the joint space.
- For the cemented version, apply a layer of cement to the bone, the implant surface or to both.
- Position the tibial baseplate and impact it using the Baseplate impactor mounted on the Universal handle.
- For the cemented version, remove any excess cement taking care to limit the movement of the components while the cement is curing.

Insertion of chosen insert:

- At this point in the procedure, trials can still be performed with a trial insert and the chosen tibial baseplate.
- Hyperflex the knee.
- Slide the insert onto the lateral baseplate rails, and then impact its anterior edge using the Tibial impactor.



NOTE

The Tibial impactor has to be slightly anteriorly inclined to ensure a better impaction of the insert.

Definitive implants

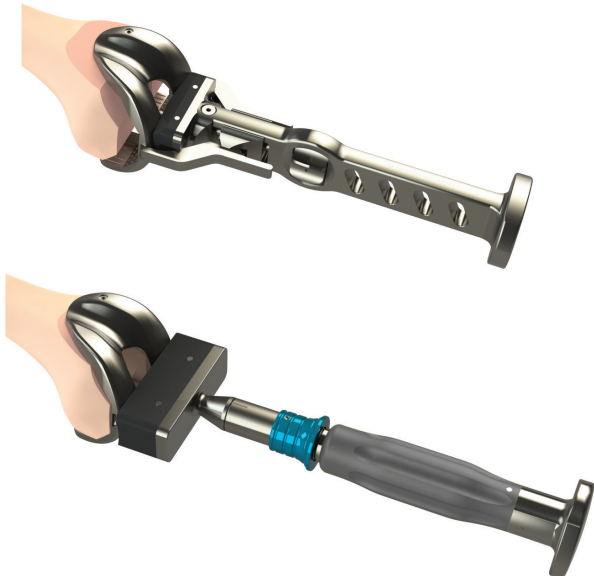

Insertion of chosen femoral component:

- Assemble the chosen femoral component (cemented or cementless) with the Femoral component holder.
- For the cemented version, apply a layer of cement to the bone, the implant surface or to both.
- Place the femoral component onto the femoral cuts, make sure it is aligned precisely, and then impact it.
- Remove the Femoral component holder.
- Finish impacting the component using the Femoral component impactor and Universal handle.
- For the cemented version, remove any excess cement taking care to limit the movement of the components while the cement is curing.
- Reduce the femoral component onto the insert.

12 Implants extraction



Tibial extraction :

- Remove the tibial insert with an osteotome.
- Assemble the Tibial baseplate extractor with the Universal handle.
- Screw them into the tibial baseplate.
- Gradually extract the component by tapping under the anvil.

NOTE

The Slap hammer can be assembled with the Universal handle to make the extraction easier.

Femoral extraction :

- Assemble the Femoral component holder on the femoral component.
- Gradually extract the component by tapping under the anvil.

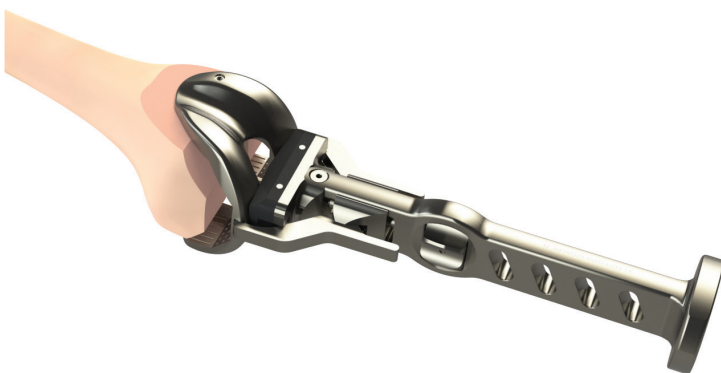



Instrumentation

The ANATOMIC conventional instrumentation* consists of 6 trays:

- Instrumentation set for **ANATOMIC Postero-stabilized : Common Set**
- Instrumentation set for **ANATOMIC PS Posterior stabilized Resection Tibial Set**
- Instrumentation set for **ANATOMIC Postero-stabilized : Tibial Trial**
- Instrumentation set for **SCORE 4 in1 with pin positionner**
- Instrumentation set for **ANATOMIC Postero-stabilized : Femoral Preparation**
- Instrumentation set for **ANATOMIC Postero-stabilized : Femoral Trial**

And either of:

- Instrumentation set for **SCORE Primary - Patellar resection set (Conventional)**
- Instrumentation set for **SCORE - Patella set - Patella reaming**

In addition:

- Instrumentation set for **ANATOMIC Postero-stabilized - Size 0 and Size 8 - 4 in 1**
- Instrumentation set for **ANATOMIC PS—Tibial Revision Set** (Cf Conventional ST ANATOMIC Tibial Revision TO.G.004 and Conventional ST ANATOMIC 4T Tibial Revision TO.G.005)
- Sterile large saw blades
- Sterile medium saw blades

* Not all devices presented in this Surgical Technique may be registered in your country. Please contact your Amplitude Sales Representative for availability.

Instrumentation

Anatomic Postero-stabilized : common set

2-02999124

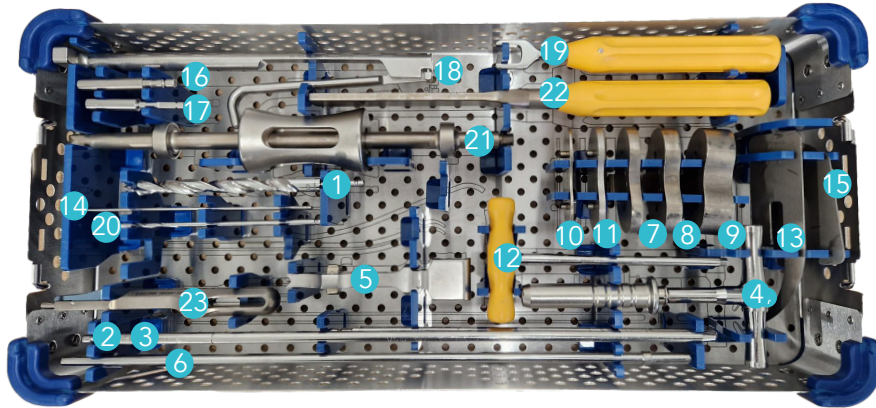

Item	Name	Product No.	Qty
1	Intramedullary drill bit	2-0200100	1
2	Intramedullary rod length 250 mm	2-0200200	1
3	Intramedullary rod length 400 mm	2-0200300	1
4	T wrench	2-0200400	1
5	Universal handle	2-0216400	1
6	Extramedullary alignment rod	2-0200600	1
7	Spacer thickness 7 mm	2-0200707	1
8	Spacer thickness 10 mm	2-0200710	1
9	Spacer thickness 18 mm	2-0200718	1
10	Spacer thickness 2 mm for spacer	2-0207002	1
11	Spacer thickness 4 mm for spacer	2-0207004	1
12	H5 Screwdriver	2-0200800	1
13	Resection gauge	2-0204500	1
14	Alignment Pin \varnothing 2 Length 150 mm	2-0103000	2
15	Alignment gauge	2-0206300	1
16	Universal quick release adaptor for pin	2-0201100	1
17	Pin Driver AO	2-0201200	1
18	Pin extractor	2-0201500	1
19	Tibial stem wrench	2-0205500	1
20	Long Drill bit \varnothing 3.2 length 145 mm	2-0102400	1
21	Slap hammer	2-0206900	1
22	Flat rasp	2-0206800	1
23	Tibial baseplate handle	2-0223500	2

Instrumentation

Anatomic PS Postero-Stabilized Resection tibial set

2-0299979

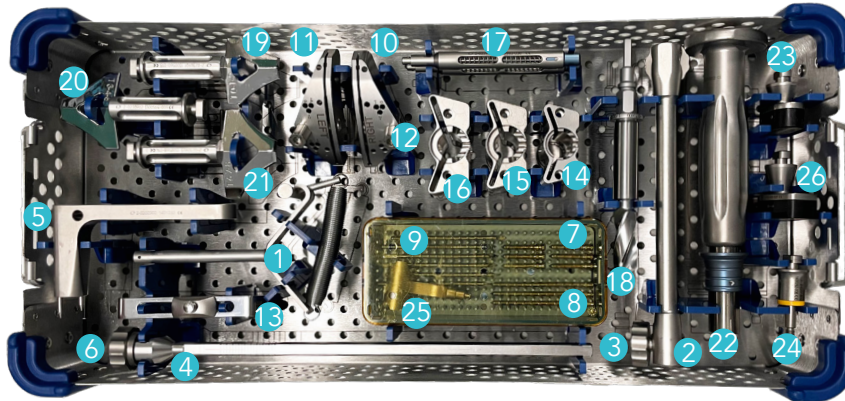

Item	Name	Product No.	Qty
1	Malleolar clamp	2-0201600	1
2	Extramedullary alignment guide	2-0201700	1
3	Wheel for extramedullary Alignment column	2-0201800	2
4	Tibial slide bar	2-0201900	1
5	Tibial bracket	2-0202000	1
6	Wheel for tibial bracket	2-0202100	1
7	Headed pin length 30 mm	2-0201301	6
8	Headed pin length 70 mm	2-0201302	3
9	Headless pin length 80 mm	2-0201400	6
10	Tibial resection guide RIGHT	2-0202200	1
11	Tibial resection guide LEFT	2-0202300	1
12	Wheel for resection guide	2-0203800	1
13	Tibial stylus	2-0202400	1
14	Guide for tibial fin punch Size 0-1-2	2-0230801	1
15	Guide for tibial fin punch Size 3-4-5	2-0230802	1
16	Guide for tibial fin punch Size 6-7-8	2-0230803	1
17	Removable hand holds	2-0226500	1
18	Reamer for tibial keel	2-0231600	1
19	Tibial fin punch size 0-1-2	2-0230901	1
20	Tibial fin punch size 3-4-5	2-0230902	1
21	Tibial fin punch size 6-7-8	2-0230903	1
22	Universal handle	2-0232100	1
23	Tibial impactor	2-0231900	1
24	Tibial baseplate extractor	2-0231800	1
25	Reference body support for tibial baseplate handle*	2-0223600	1
26	Baseplate impactor	2-0233400	1

* Not use in this surgical technique. Please refer to appropriate CAS 5 in 1 Surgical Technique for its description.



Instrumentation

Anatomic PS Postero-Stabilized Tibial trial

2-02999124



Item	Name	Product No.	Qty
1	ANATOMIC Trial baseplate posterior stabilized Size 1	2-0231001	1
2	ANATOMIC Trial baseplate posterior stabilized Size 2	2-0231002	1
3	ANATOMIC Trial baseplate posterior stabilized Size 3	2-0231003	1
4	ANATOMIC Trial baseplate posterior stabilized Size 4	2-0231004	1
5	ANATOMIC Trial baseplate posterior stabilized Size 5	2-0231005	1
6	ANATOMIC Trial baseplate posterior stabilized Size 6	2-0231006	1
7	ANATOMIC Trial baseplate posterior stabilized Size 7	2-0231007	1
8	ANATOMIC Trial fixed bearing insert, PS - Size 1, Height 10 mm	2-0230610	1
8	ANATOMIC Trial fixed bearing insert, PS - Size 1, Height 12 mm	2-0230611	1
8	ANATOMIC Trial fixed bearing insert, PS - Size 1, Height 14 mm	2-0230612	1
8	ANATOMIC Trial fixed bearing insert, PS - Size 1, Height 16 mm	2-0230613	1
8	ANATOMIC Trial fixed bearing insert, PS - Size 1, Height 18 mm	2-0230614	1
8	ANATOMIC Trial fixed bearing insert, PS - Size 1, Height 20 mm	2-0230615	1
9	ANATOMIC Trial fixed bearing insert, PS - Size 2, Height 10 mm	2-0230620	1
9	ANATOMIC Trial fixed bearing insert, PS - Size 2, Height 12 mm	2-0230621	1
9	ANATOMIC Trial fixed bearing insert, PS - Size 2, Height 14 mm	2-0230622	1
9	ANATOMIC Trial fixed bearing insert, PS - Size 2, Height 16 mm	2-0230623	1
9	ANATOMIC Trial fixed bearing insert, PS - Size 2, Height 18 mm	2-0230624	1
9	ANATOMIC Trial fixed bearing insert, PS - Size 2, Height 20 mm	2-0230625	1
10	ANATOMIC Trial fixed bearing insert, PS - Size 3, Height 10 mm	2-0230630	1
10	ANATOMIC Trial fixed bearing insert, PS - Size 3, Height 12 mm	2-0230631	1
10	ANATOMIC Trial fixed bearing insert, PS - Size 3, Height 14 mm	2-0230632	1
10	ANATOMIC Trial fixed bearing insert, PS - Size 3, Height 16 mm	2-0230633	1
10	ANATOMIC Trial fixed bearing insert, PS - Size 3, Height 18 mm	2-0230634	1
10	ANATOMIC Trial fixed bearing insert, PS - Size 3, Height 20 mm	2-0230635	1



Instrumentation

Anatomic : PS Postero-Stabilized Tibial trial

2-02999124



Item	Name	Product No.	Qty
11	ANATOMIC Trial fixed bearing insert, PS - Size 4, Height 10 mm	2-0230640	1
11	ANATOMIC Trial fixed bearing insert, PS - Size 4, Height 12 mm	2-0230641	1
11	ANATOMIC Trial fixed bearing insert, PS - Size 4, Height 14 mm	2-0230642	1
11	ANATOMIC Trial fixed bearing insert, PS - Size 4, Height 16 mm	2-0230643	1
11	ANATOMIC Trial fixed bearing insert, PS - Size 4, Height 18 mm	2-0230644	1
12	ANATOMIC Trial fixed bearing insert, PS - Size 4, Height 20 mm	2-0230645	1
12	ANATOMIC Trial fixed bearing insert, PS - Size 5, Height 10 mm	2-0230650	1
12	ANATOMIC Trial fixed bearing insert, PS - Size 5, Height 12 mm	2-0230651	1
12	ANATOMIC Trial fixed bearing insert, PS - Size 5, Height 14 mm	2-0230652	1
12	ANATOMIC Trial fixed bearing insert, PS - Size 5, Height 16 mm	2-0230653	1
12	ANATOMIC Trial fixed bearing insert, PS - Size 5, Height 18 mm	2-0230654	1
12	ANATOMIC Trial fixed bearing insert, PS - Size 5, Height 20 mm	2-0230655	1
13	ANATOMIC Trial fixed bearing insert, PS - Size 6, Height 10 mm	2-0230660	1
13	ANATOMIC Trial fixed bearing insert, PS - Size 6, Height 12 mm	2-0230661	1
13	ANATOMIC Trial fixed bearing insert, PS - Size 6, Height 14 mm	2-0230662	1
13	ANATOMIC Trial fixed bearing insert, PS - Size 6, Height 16 mm	2-0230663	1
13	ANATOMIC Trial fixed bearing insert, PS - Size 6, Height 18 mm	2-0230664	1
13	ANATOMIC Trial fixed bearing insert, PS - Size 6, Height 20 mm	2-0230665	1
14	ANATOMIC Trial fixed bearing insert, PS - Size 7, Height 10 mm	2-0230670	1
14	ANATOMIC Trial fixed bearing insert, PS - Size 7, Height 12 mm	2-0230671	1
14	ANATOMIC Trial fixed bearing insert, PS - Size 7, Height 14 mm	2-0230672	1
14	ANATOMIC Trial fixed bearing insert, PS - Size 7, Height 16 mm	2-0230673	1
14	ANATOMIC Trial fixed bearing insert, PS - Size 7, Height 18 mm	2-0230674	1
14	ANATOMIC Trial fixed bearing insert, PS - Size 7, Height 20 mm	2-0230675	1

Instrumentation

Score 4 in 1 with pin positionner (conventional)

2-0299941

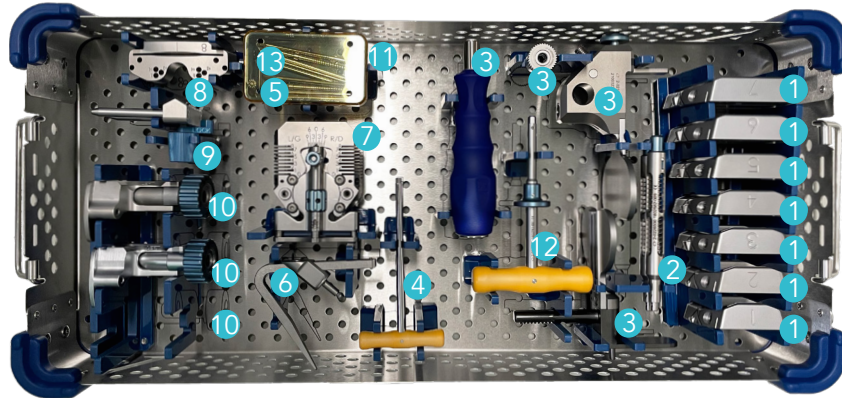

Item	Name	Product No.	Qty
1	4-in-1 femoral resection guide Size 1	2-0226401	1
1	4-in-1 femoral resection guide Size 2	2-0226402	1
1	4-in-1 femoral resection guide Size 3	2-0226403	1
1	4-in-1 femoral resection guide Size 4	2-0226404	1
1	4-in-1 femoral resection guide Size 5	2-0226405	1
1	4-in-1 femoral resection guide Size 6	2-0226406	1
1	4-in-1 femoral resection guide Size 7	2-0226407	1
2	Removable hand holds	2-0226500	2
3	Extra-articular ligament balancer V2	2-0233200	1
4	Screwdriver H3.5*	2-0225500	1
5	Headless pin Ø 3.2 Length 65 mm	2-0201402	6
6	4-in-1 probe	2-0229900	1
7	4-in-1 pin positionner	2-0229800	1
8	Distal Resection Guide 8 mm	2-0226900	1
8	Distal Resection Guide 10 mm	2-0228900	1
9	Distal slide bar	2-0226800	1
10	Femoral Valgus Aligement Guide 0°	2-0226600	1
10	Femoral Valgus Aligement Guide 3°	2-0226603	1
10	Femoral Valgus Aligement Guide 6°	2-0226606	1
11	H2.5 Wrench	2-0228200	1
12	Snap screwdriver H5	2-0233100	1
13	Threaded Non-Headed Pin Lg 65mm	2-0255401	2

* The Screwdriver H3.5 is used in some version of the Femoral Alignment Guide 0°, 3° or 6° to tighten the 2 frontal screws which can locked the Distal Slide Bar.

Instrumentation

ANATOMIC PS Postero-Stabilized Femoral preparation

2-02999124

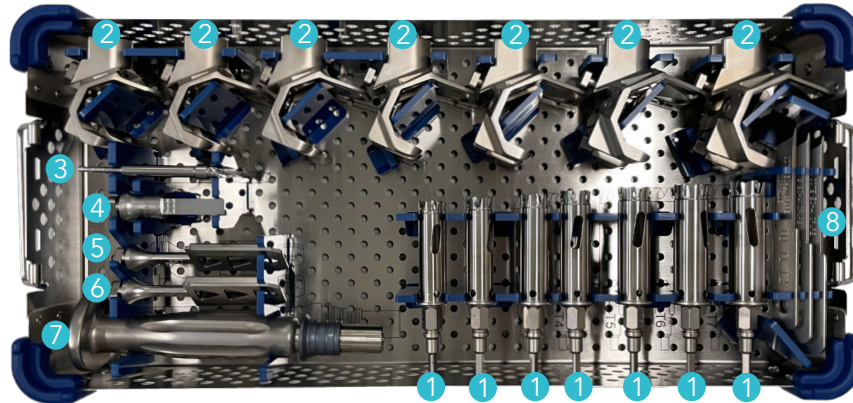

Item	Name	Product No.	Qty
1	Notch reamer Size 1	2-0231301	1
1	Notch reamer Size 2	2-0231302	1
1	Notch reamer Size 3	2-0231303	1
1	Notch reamer Size 4	2-0231304	1
1	Notch reamer Size 5	2-0231305	1
1	Notch reamer Size 6	2-0231306	1
1	Notch reamer Size 7	2-0231307	1
2	Femoral preparation guide Size 1	2-0230701	1
2	Femoral preparation guide Size 2	2-0230702	1
2	Femoral preparation guide Size 3	2-0230703	1
2	Femoral preparation guide Size 4	2-0230704	1
2	Femoral preparation guide Size 5	2-0230705	1
2	Femoral preparation guide Size 6	2-0230706	1
2	Femoral preparation guide Size 7	2-0230707	1
3	Drill for peg holes	2-0204000	1
4	L-shape chisel	2-0231700	1
5	Right Trochlea box chisel	2-0231400	1
6	Left Trochlea box chisel	2-0231500	1
7	Universal handle	2-0232100	1
8	Osteotome Size 0-1-2	2-0233700	1
8	Osteotome Size 3-4-5	2-0233701	1
8	Osteotome Size 6-7-8	2-0233702	1

Instrumentation

ANATOMIC: PS Postero-Stabilized Femoral trial

2-02999124

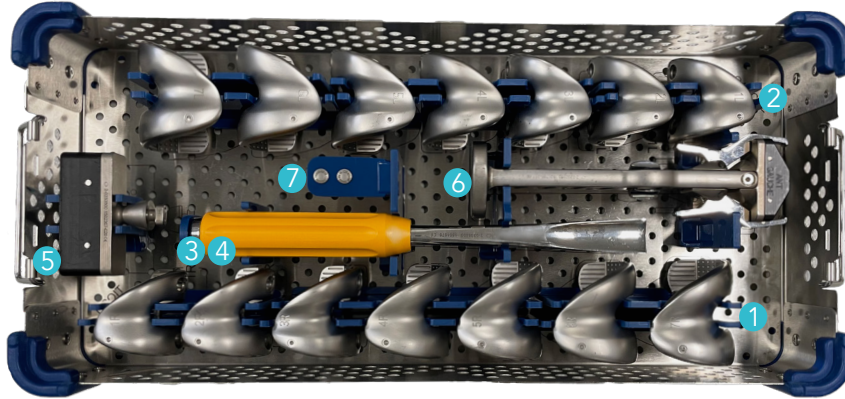

Item	Name	Product No.	Qty
1	ANATOMIC Trial femoral component posterior stabilized right Size 1	2-0231101	1
1	ANATOMIC Trial femoral component posterior stabilized right Size 2	2-0231102	1
1	ANATOMIC Trial femoral component posterior stabilized right Size 3	2-0231103	1
1	ANATOMIC Trial femoral component posterior stabilized right Size 4	2-0231104	1
1	ANATOMIC Trial femoral component posterior stabilized right Size 5	2-0231105	1
1	ANATOMIC Trial femoral component posterior stabilized right Size 6	2-0231106	1
1	ANATOMIC Trial femoral component posterior stabilized right Size 7	2-0231107	1
2	ANATOMIC Trial femoral component posterior stabilized left Size 1	2-0231201	1
2	ANATOMIC Trial femoral component posterior stabilized left Size 2	2-0231202	1
2	ANATOMIC Trial femoral component posterior stabilized left Size 3	2-0231203	1
2	ANATOMIC Trial femoral component posterior stabilized left Size 4	2-0231204	1
2	ANATOMIC Trial femoral component posterior stabilized left Size 5	2-0231205	1
2	ANATOMIC Trial femoral component posterior stabilized left Size 6	2-0231206	1
2	ANATOMIC Trial femoral component posterior stabilized left Size 7	2-0231207	1
3	Cutting gauge	2-0206500	1
4	Unicompartmental osteotome	2-0221500	1
5	Femoral component impactor	2-0233500	1
6	Femoral component holder	2-0232000	1
7	Trial peg for trial femoral component	2-0233300	2

Instrumentation

Score Primary - Patella resection set (conventional)

2-02999132

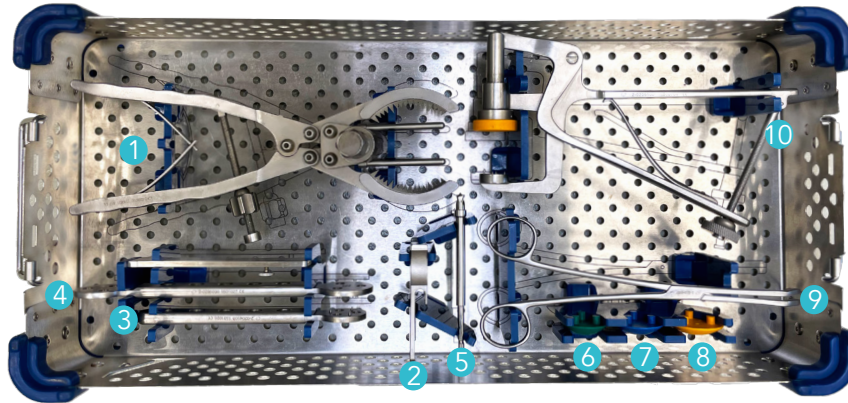

Item	Name	Product No.	Qty
1	Patellar Resection Clamp	2-0206700	1
2	Patellar resection gauge	2-0208400	1
3	Patellar Drilling Guide Ø30	2-0204900	1
4	Patellar Drilling Guide Ø33 and Ø36	2-0205000	1
5	Drill Bit for Resurfacing Patella	2-0205100	1
6	Trial resurfacing patella Ø 30	2-0205330	1
7	Rotule d'essai de resurfaçage Ø33	2-0205333	1
8	Rotule d'essai de resurfaçage Ø36	2-0205336	1
9	Clamp for Locking Ring	2-0104600	1
10	Patellar Impaction Clamp	2-0206100	1

Instrumentation

Score - Patella set - Patella reaming

2-0299917

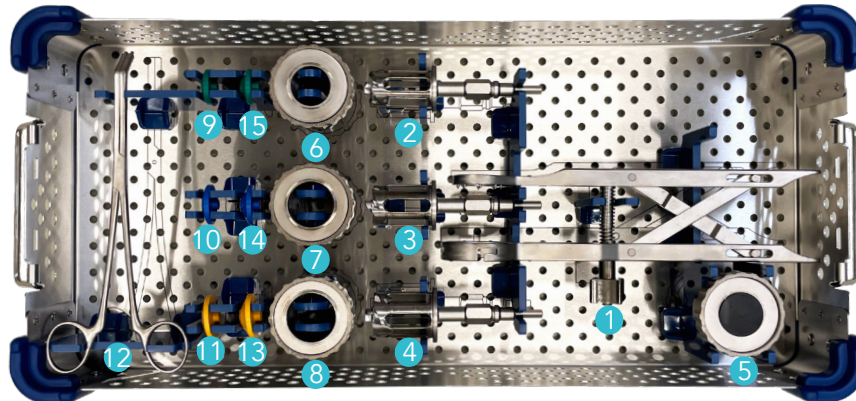

Item	Name	Product No.	Qty
1	Patella Reamer Clamp	2-0216600	1
2	Reamer for inset cementless patellar Ø 23	2-0216523	1
3	Reamer for inset cementless patellar Ø 26	2-0216526	1
4	Reamer for inset cementless patellar Ø 29	2-0216529	1
5	Patellar Reamer Impaction Clamp	2-0216800	1
6	Patella Reamer Surfacing Guides Ø 23	2-0216723	1
7	Patella Reamer Surfacing Guides Ø 26	2-0216726	1
8	Patella Reamer Surfacing Guides Ø 29	2-0216729	1
9	Trial Inset Patellar - Cemented Ø 23 - Plastic	2-0205223	1
10	Trial Inset Patellar - Cemented Ø 26 - Plastic	2-0205226	1
11	Trial Inset Patellar - Cemented Ø 29 - Plastic	2-0205229	1
12	Clamp for Locking Ring	2-0104600	1
13	Trial Inset Patellar - Cementless Ø 29 - Plastic	2-0216929	1
14	Trial Inset Patellar - Cementless Ø 26 - Plastic	2-0216926	1
15	Trial Inset Patellar - Cementless Ø 23 - Plastic	2-0216923	1

Instrumentation

Anatomic PS optional set Size 0 and Size 8 - 4 in 1

2-0299959

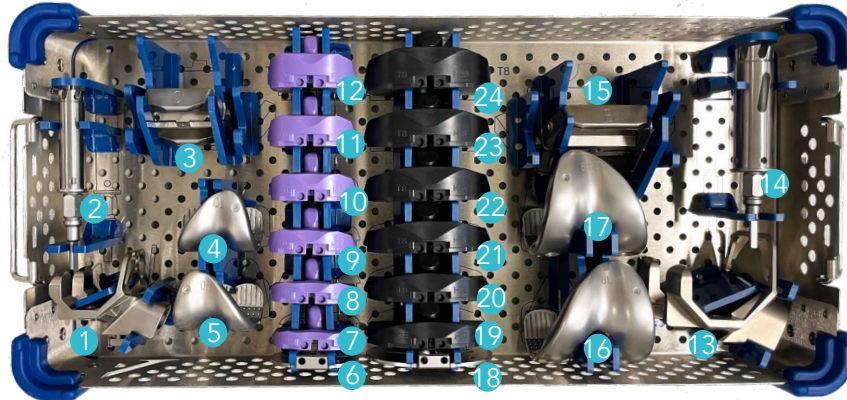

Item	Name	Product No.	Qty
1	Femoral preparation guide Size 0	2-0230700	1
2	Notch reamer Size 0	2-0231300	1
3	4-in-1 femoral resection guide Size 0	2-0226400	1
4	ANATOMIC Trial femoral component posterior stabilized left Size 0	2-0231200	1
5	ANATOMIC Trial femoral component posterior stabilized right Size 0	2-0231100	1
6	ANATOMIC Trial baseplate posterior stabilized Size 0	2-0231000	1
7	ANATOMIC Trial fixed bearing insert, PS - Size 0, Height 10 mm	2-0230601	1
8	ANATOMIC Trial fixed bearing insert, PS - Size 0, Height 12 mm	2-0230602	1
9	ANATOMIC Trial fixed bearing insert, PS - Size 0, Height 14 mm	2-0230603	1
10	ANATOMIC Trial fixed bearing insert, PS - Size 0, Height 16 mm	2-0230604	1
11	ANATOMIC Trial fixed bearing insert, PS - Size 0, Height 18 mm	2-0230605	1
12	ANATOMIC Trial fixed bearing insert, PS - Size 0, Height 20 mm	2-0230606	1
13	Femoral preparation guide Size 8	2-0230708	1
14	Notch reamer Size 8	2-0231308	1
15	4-in-1 femoral resection guide Size 8	2-0226408	1
16	ANATOMIC Trial femoral component posterior stabilized right Size 8	2-0231108	1
17	ANATOMIC Trial femoral component posterior stabilized left Size 8	2-0231208	1
18	ANATOMIC Trial baseplate posterior stabilized Size 8	2-0231008	1
19	ANATOMIC Trial fixed bearing insert, PS - Size 8, Height 10 mm	2-0230680	1
20	ANATOMIC Trial fixed bearing insert, PS - Size 8, Height 12 mm	2-0230681	1
21	ANATOMIC Trial fixed bearing insert, PS - Size 8, Height 14 mm	2-0230682	1
22	ANATOMIC Trial fixed bearing insert, PS - Size 8, Height 16 mm	2-0230683	1
23	ANATOMIC Trial fixed bearing insert, PS - Size 8, Height 18 mm	2-0230684	1
24	ANATOMIC Trial fixed bearing insert, PS - Size 8, Height 20 mm	2-0230685	1

Instrumentation

Large saw blades

SYNTHES AO / SODEM large Sawblade
Sterile Product No. 2-0227901

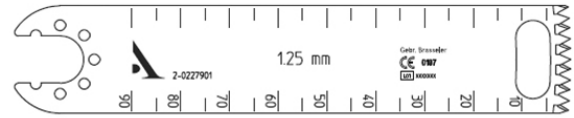

STRYKER large Sawblade
Sterile Product No. 2-0227902

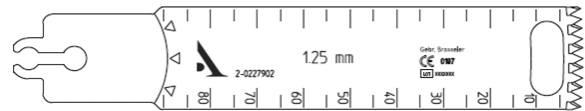

ZIMMER / HALL / LINVATEC large Sawblade
Sterile Product No. 2-0227903

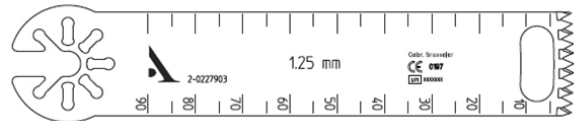

Medium saw blades

SYNTHES AO / SODEM medium Sawblade
Sterile Product No. 2-0228001

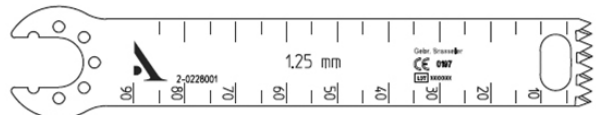

STRYKER medium Sawblade
Sterile Product No. 2-0228002

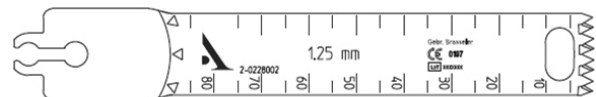

ZIMMER / HALL / LINVATEC medium Sawblade
Sterile Product No. 2-0228003



Appendix A

Assembly and disassembly of the ligament balancer

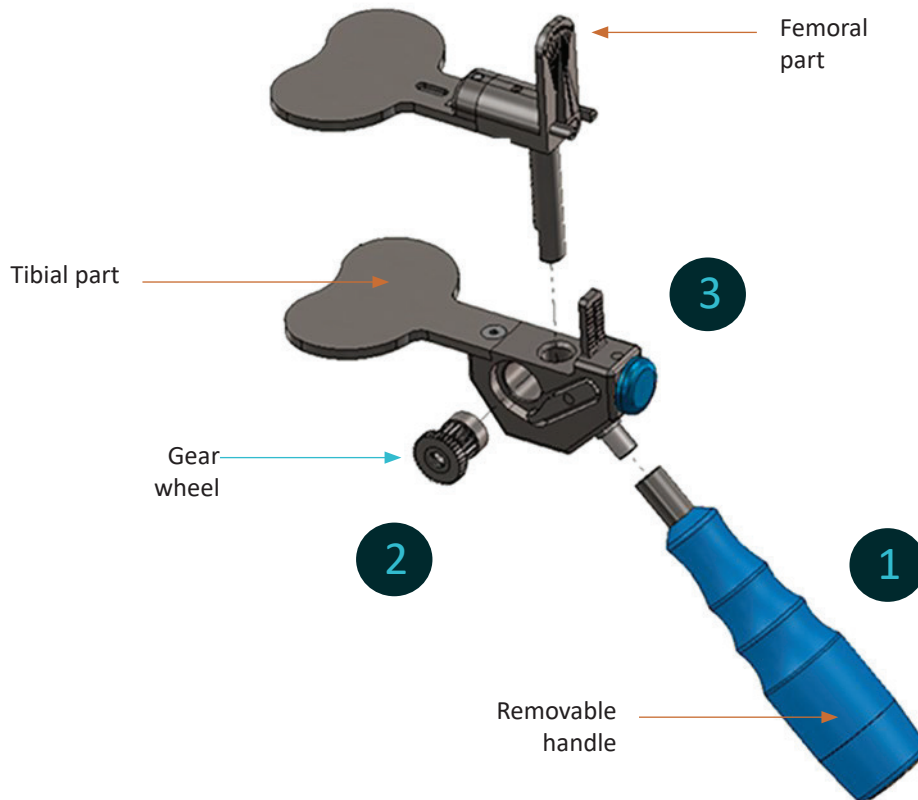

Assembly of Balancer:

- 1 Screw the removable handle onto the tibial housing.
- 2 Place the gear wheel into the lateral opening on the tibial housing.
- 3 Press the blue button and insert the femoral housing on top of the tibial housing

Dissassembly of the Balancer:

Repeat the above steps in the reverse order.

Appendix B

Assembly and disassembly of the 4 in 1 pin positionner

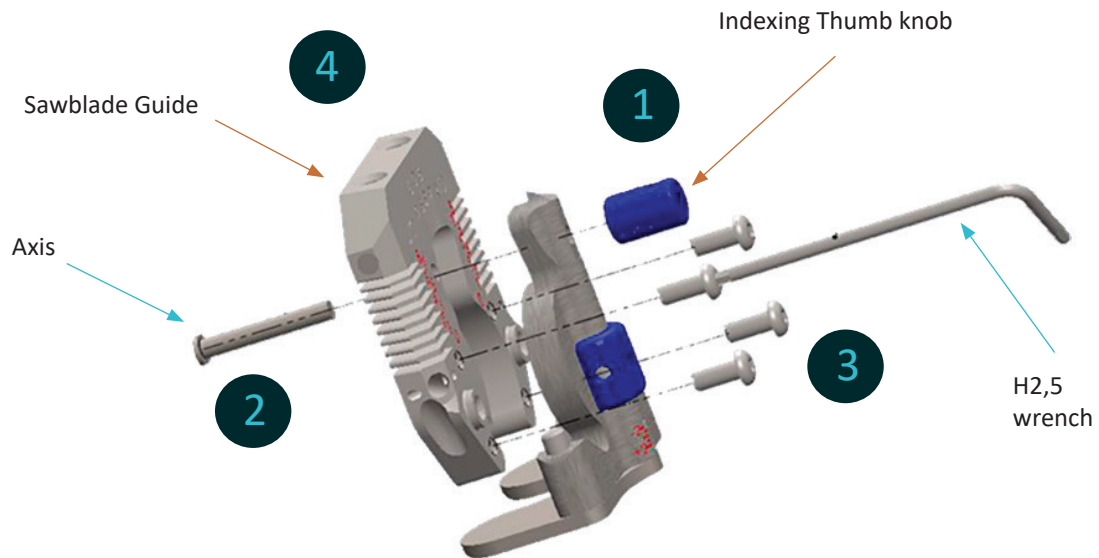

Disassembly of Pin Positioner:

- 1 Unscrew the indexing thumb knob.
- 2 Remove the dowel.
- 3 Unscrew the pan-head screw with the H2.5 wrench.
- 4 Remove the saw blade guide.

Assembly of Pin Positioner:

Repeat the above steps in the reverse order.

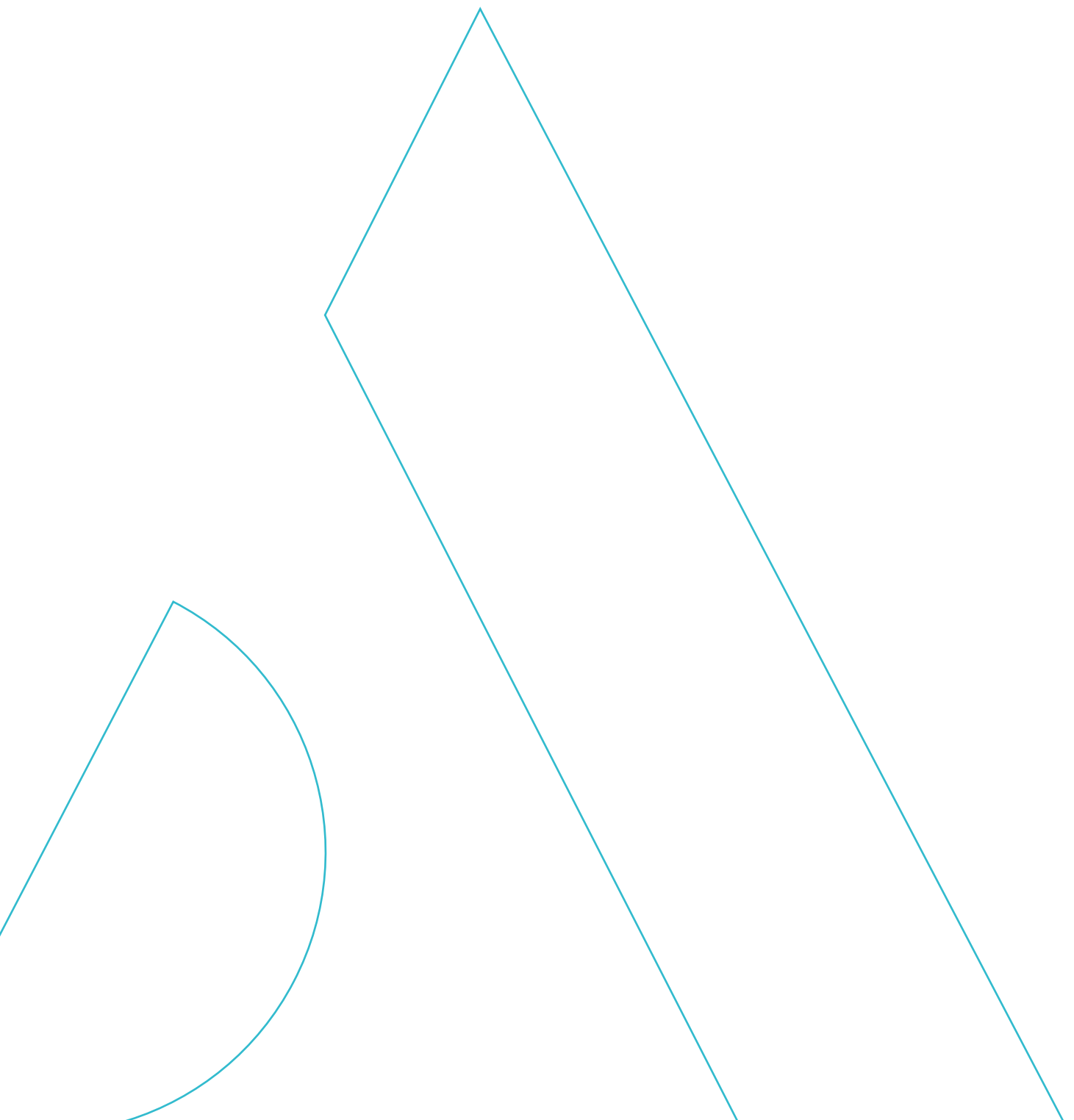



Service Clients – France:

Porte du Grand Lyon,
01700 Neyron – France
Phone: **+33 (0)4 37 85 19 19**
Fax: +33 (0)4 37 85 19 18
E-mail: amplitude@amplitude-ortho.com

Customer Service – Export:

11, cours Jacques Offenbach, ZA Mozart 2,
26000 Valence – France
Phone: **+33 (0)4 75 41 87 41**
Fax: +33 (0)4 75 41 87 42

www.amplitude-ortho.com

Reference: TO.G.002/EN/B