



SURGICAL TECHNIQUE



Summary

Introduction	4
Overview of the implant	5
Overview of the surgical technique	12
Etape 1 - Pre-operative planning	15
Etape 2 - Intra-medullary guide	16
Extra-medullary guide	17
Combined tibial guide	18
Etape 3 - Tibial resection	19
Etape 4 - Extension and flexion gaps	20
Etape 5 - Femoral positioning	21
Etape 6 - Femoral resections	25
Etape 7 - Extension and flexion gaps	26
Etape 8 - Distal Femoral recutting	27
Etape 9 - Changing sizes	27
Etape 10 - Femoral preparation	28
Etape 11 - Positioning of the trial femoral component	30
Etape 12 - Tibial preparation	31
Etape 13 - Patella preparation : Patellar resection option	33
Patella preparation : Patellar reaming option	34
Etape 14 - Definitive implants	35
Etape 15 - Implants extraction	37
Option : Simulated gap balancing before femoral cuts	38
Option : Distal femoral pre-cut	39
Option : MIS Femoral resection guides	40
Instrumentation	42

Introduction

- This surgical technique relates to the anatomic instrumentation and the 5-in-1 femoral resection instrumentation used to implant the anatomic Total Knee System (TKS).
- The instrumentation can be used either:
 - in conventional (mechanical) version
 - in Computer-Assisted Surgery version (by adding the AMPLIVISION Navigation Set)
 - with the i.M.A.G.E. Patient Specific Instrumentation (by adding the i.M.A.G.E. 5-in-1 for TKA set).

Not all devices presented in this Surgical Technique may be registered in your country. Please contact your Amplitude Sales Representative for availability.



Overview of the implant

- ▶ The anatomic TKS is a PCL-sacrificing, posterior-stabilized, fixed bearing implant for primary knee arthroplasty.
- ▶ Its mediolateral coverage matches the morphology of the femur.
- ▶ Stability is provided:
 - in extension thanks to a congruent anterior lip,
 - in flexion thanks to a late contact between the cam and the post of the posterior stabilization mechanism.



Femoral component

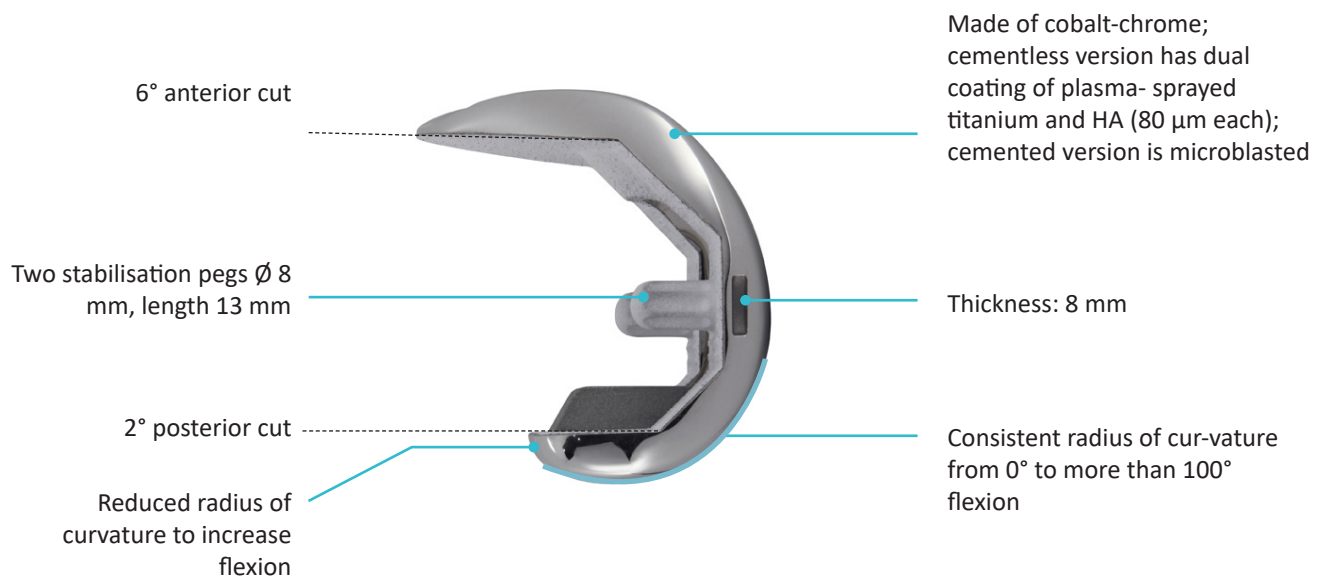

Trochlear groove lateralised by an average of 2.3 mm



Asymmetrical contact surfaces: quasi-physiological joint kinematics



Post-cam contact beyond 90 flexion and up to 130° flexion

Patellar component

Polyethylene patellar implant available in two versions:

**Resurfacing patellar implant—
cemented**

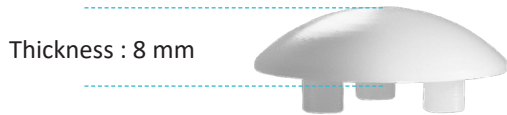

**Inset patellar implant—
cemented**

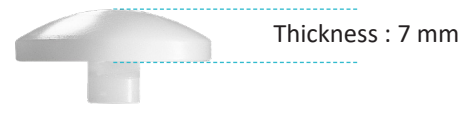

Tibial component

Tibial insert:

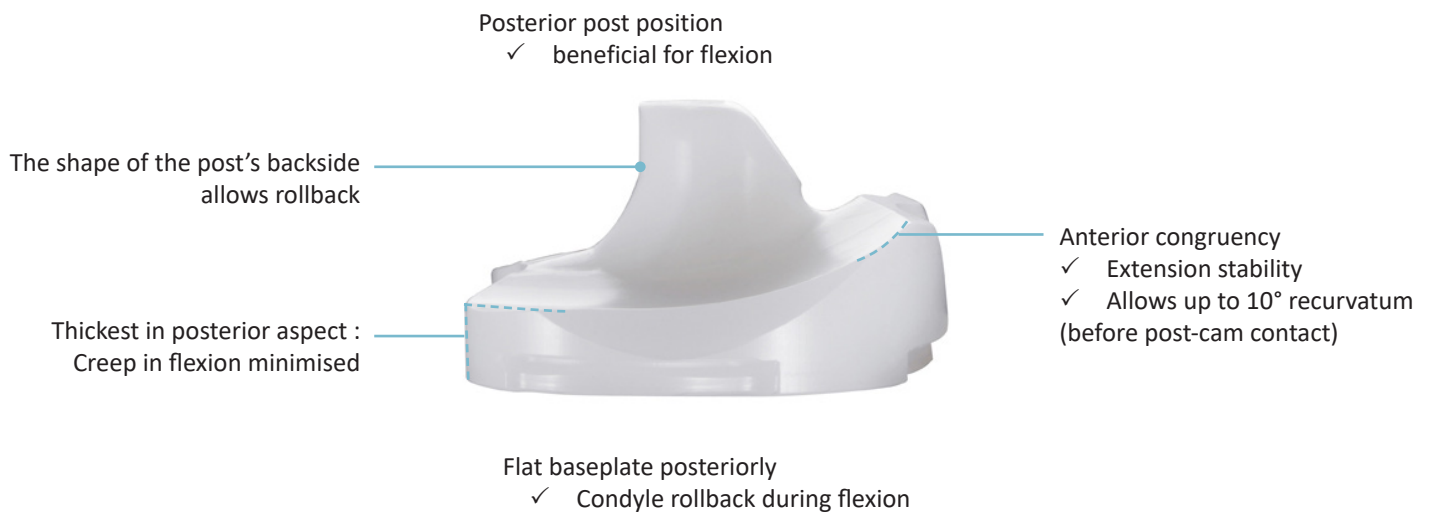

Tibial component

Tibial baseplate:

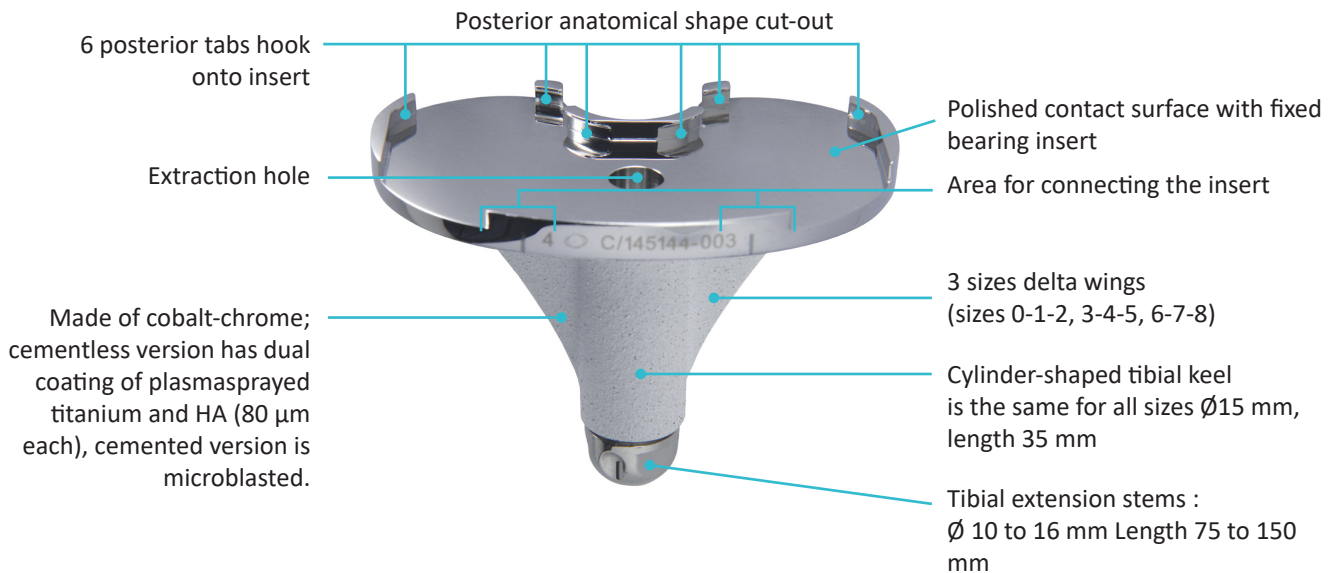

Possibility of using (e.g. in cases of UKA revision or TKA after osteotomy):

-Tibial extension stems:

- Ø10 to 16 mm
- Length 75 to 150 mm

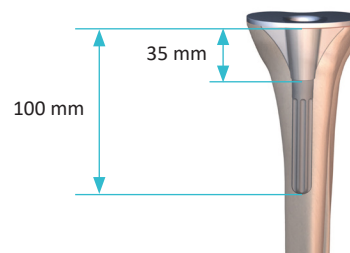

Example with a 100mm long extension stem

Length	Diameter			
75	10	12	14	
100	10	12	14	16
150	10	12	14	16

anatomic tibial augments:

- Thickness 5 mm
- Thickness 10 mm
- Thickness 15 mm



Product range

Femoral components:

- Cemented: 9 sizes (0 and 8 are optional)
- Cementless: 9 sizes (0 and 8 are optional)

Mediolateral implant coverage matches bone morphology

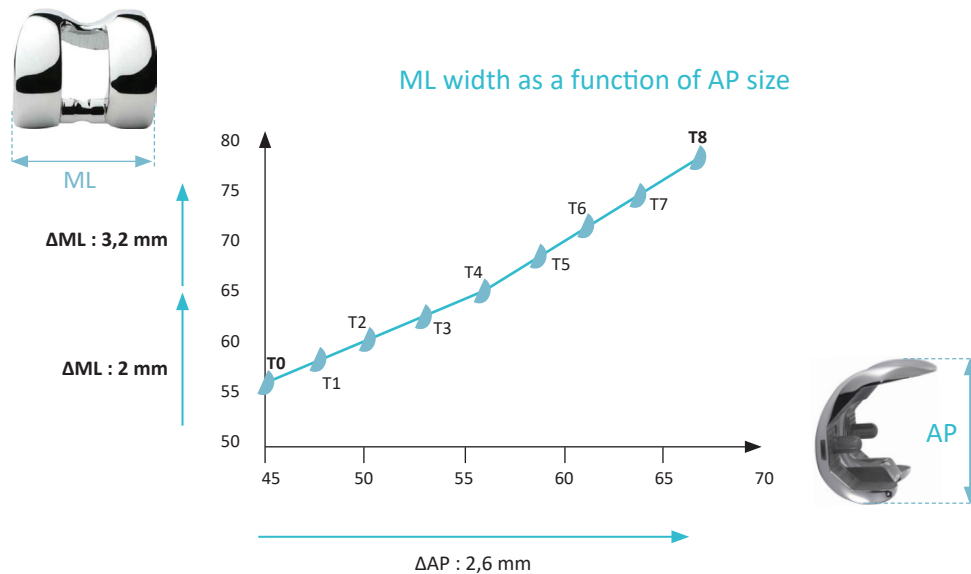

Patellar components:

- Resurfacing patellar implant – cemented: \varnothing 30, 33 and 36 mm
- Inset patellar implant – cemented: \varnothing 23, 26 and 29 mm

Tibial components:

- Cemented: 9 sizes (0 and 8 are optional)
- Cementless: 9 sizes (0 and 8 are optional)

Inserts:

- 9 sizes (0 and 8 are optional)
- 6 thicknesses (10, 12, 14, 16, 18 et 20 mm)

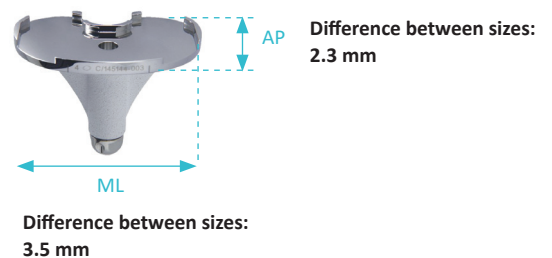

Components compatibility

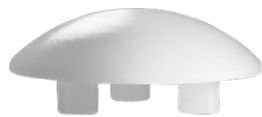
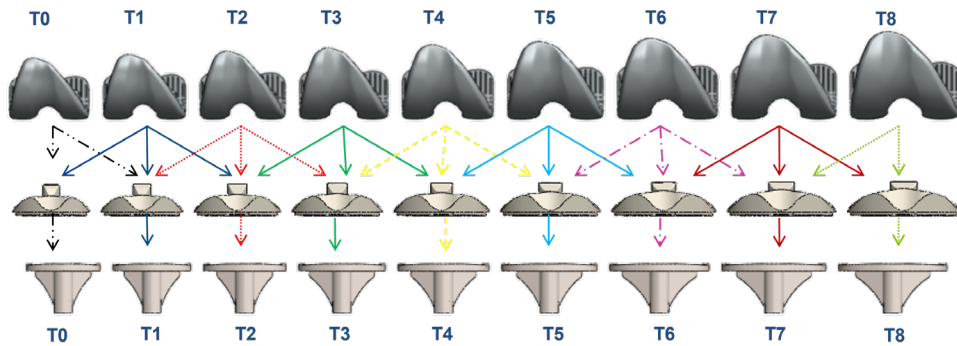

All sizes of cemented resurfacing patellar implants are compatible with all sizes of anatomic posterior stabilized femoral components.
anatomic femoral component size 7 and size 8 are not compatible with cemented inset patellar implant \varnothing 23 mm.

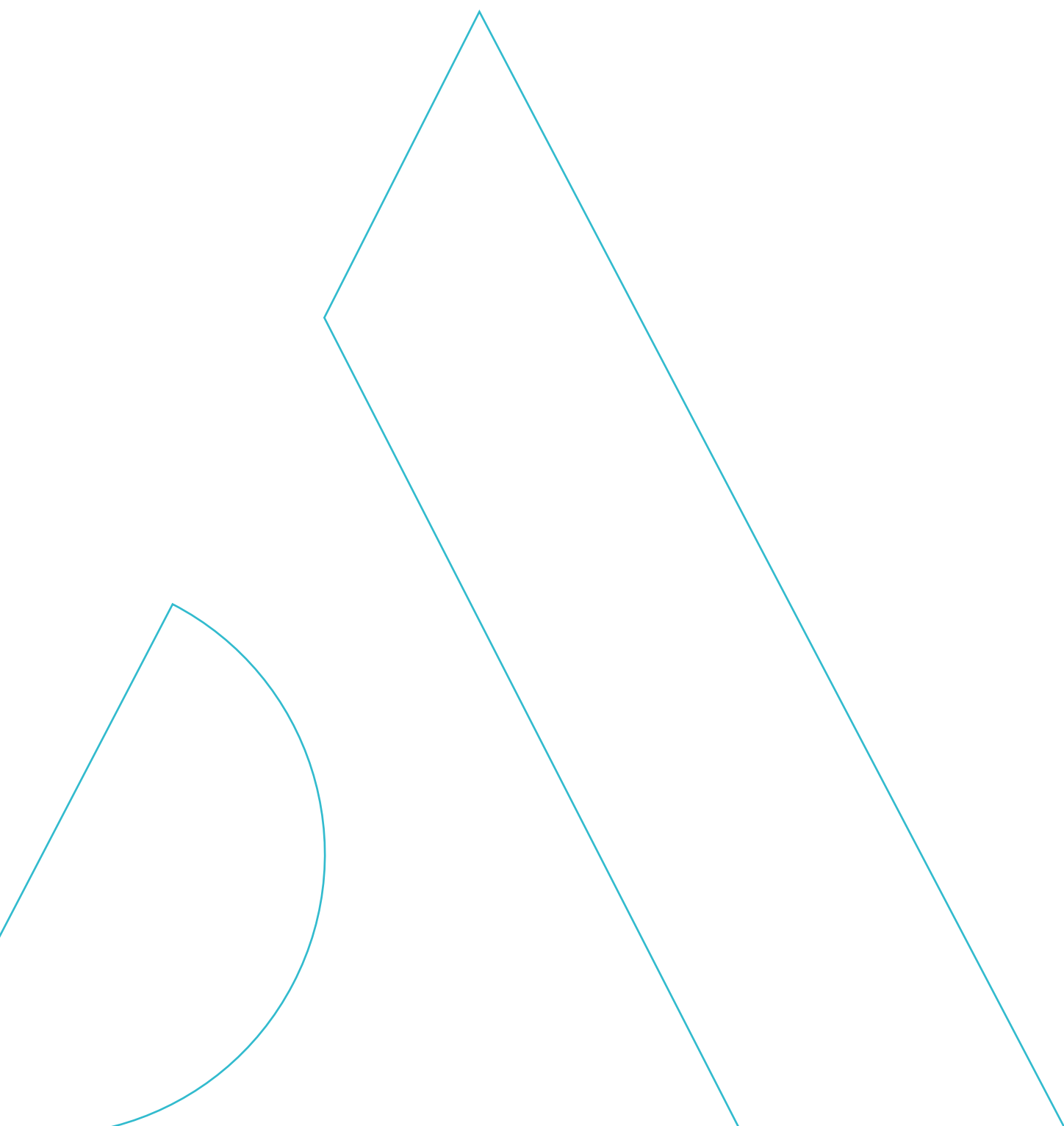

Overview of the surgical technique

1

Intramedullary tibial aiming



2

Extramedullary tibial aiming



3

Tibial cut

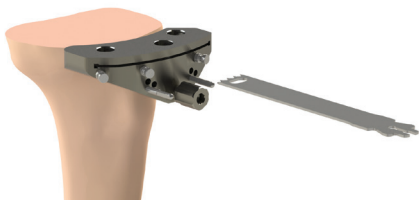

4

Femoral size selection

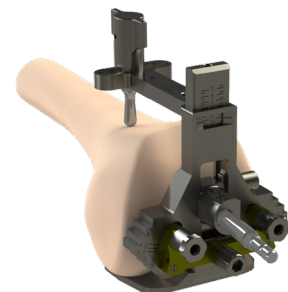

Overview of the surgical technique

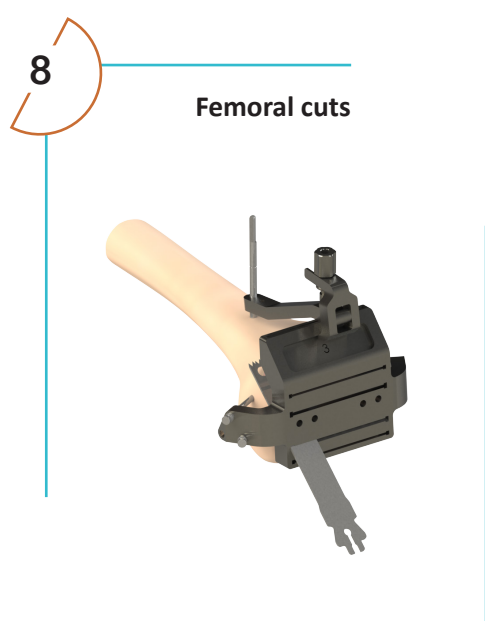
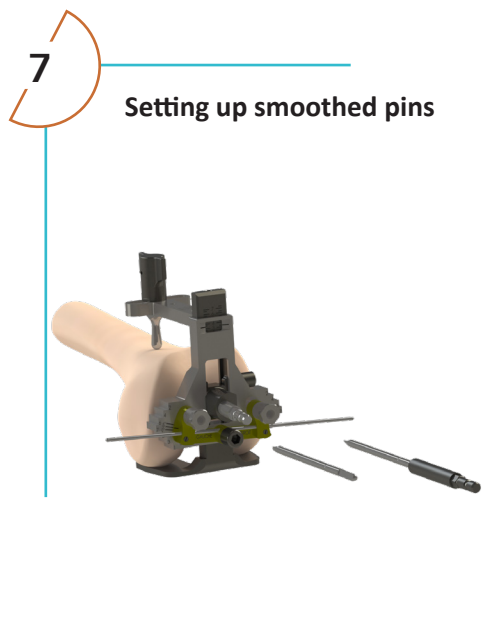
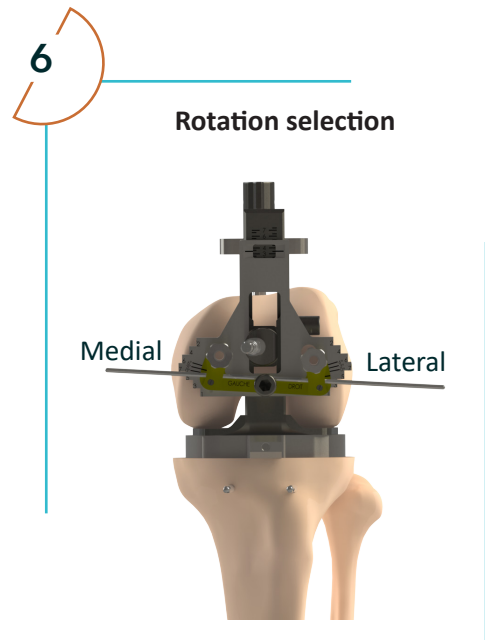
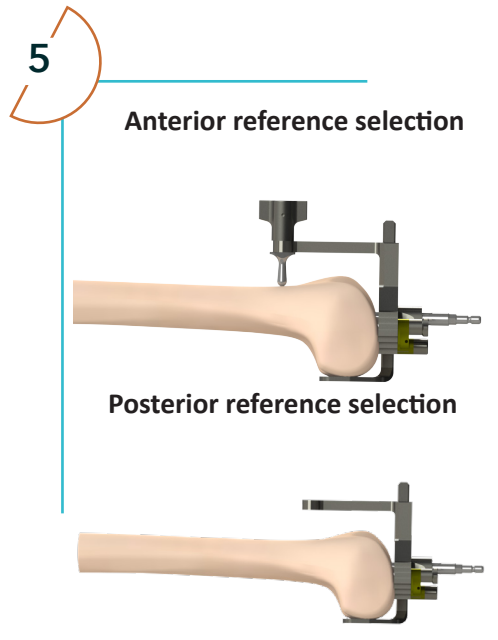

Overview of the surgical technique

9

Femoral preparation

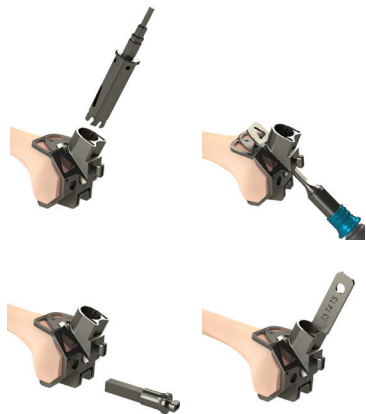

10

Tibial preparation



11

Patellar preparation
Resurfacing option



12

Patellar preparation
Patellar reaming option



1 Pre-operative planning

Using X rays and templates, you can determine concerning bone :

On the tibia :

- The choice between intramedullary and extramedullary aiming.
- The entry point of the intramedullary rod (coronal and sagittal view).
- The adaptation of the tibial stem to the metaphysis (in case of previous tibial osteotomy).
- The osteophytes.
- The severity of the compartment wear.
- The choice of an extension tibial stem, if required.
- The assessment of the baseplate size and the insert thickness.

On the femur :

- The entry point of the intramedullary rod (front and sideways).
- The anatomical femoral valgus angle.
- The posterior osteophytes.
- The size.

On the patella :

- The wear of the patellofemoral joint.
- The thickness, the width, the global shape, the tilt and the height of the patella.
- The thickness and the orientation of the patellar resection.
- The mediolateral position of the patellar implant.

NOTE

The provided templates have a 1:1 scale. Make sure the template scale matches the X-ray scale.

REMINDER

This surgical technique describes how to use the instrumentation properly. The surgeon is fully responsible for choosing the surgical approach and technique.

2 Intra-medullary guide (IM)



Intramedullary tibial alignment:

- Based on the pre-operative planning, determine the entry point for the intramedullary (IM) canal and open it with the Intramedullary drill bit.
- Assemble the Intramedullary rod length 400 mm on the T wrench and insert it into the canal, the landmark must always be visible.

NOTE

If the intramedullary rod length 400 mm cannot be inserted use the Intramedullary rod length 250 mm.

Assembly of the Intramedullary System:

- Attach the Tibial slide bar and the Tibial resection guide (left or right) together onto the Tibial bracket. Tighten the Wheel for resection guide and the Wheel for tibial bracket with the H5 Screwdriver or by hand.
- Insert this entire unit onto the Intramedullary rod, adjust its rotation relative to the anterior tibial tuberosity and then impact the tabs.
- Clip the Tibial stylus onto the resection guide (make sure the clip is fully engaged).
- Set the resection height by using the Tibial stylus to palpate either the:
 - healthy side (10 mm cut relative to the chosen point),
 - worn side (0 mm cut relative to the chosen point (exit level of the saw blade)).
- For other resection heights, use the 2 mm markings on the Tibial slide bar.
- Verify the height of the bone cut with the Resection gauge.



NOTE

To determine if the tibial slide bar is perpendicular to the tibial cut, slide the universal handle onto the slide bar and use the alignment gauge to verify the alignment.

2 Extra-medullary guide (EM)



Assembly of the Extramedullary System and resection height adjustment:

- Attach the Tibial slide bar and the Tibial resection guide (left or right) together onto the Tibial bracket. Tighten the Wheel for resection guide and the Wheel for tibial bracket with the H5 Screwdriver or by hand.
- Assemble the Malleolar clamp with the Extramedullary alignment guide and with the Tibial slide bar.
- Place the Malleolar clamp around the ankle, and then place the Tibial bracket on the intercondylar eminence.
- Tightened the Wheel for extramedullary Alignment column.
- Set the rotational and sagittal alignments before impacting the tabs.
- Clip the Tibial stylus onto the Tibial resection guide (make sure the clip is fully engaged).
- Set the resection height by using the Tibial stylus to palpate either the:
 - healthy side (10 mm cut relative to the chosen point),
 - worn side (0 mm cut relative to the chosen point (exit level of the saw blade)).
- For other resection heights, use the 2 mm markings on the tibial slide bar.
- Verify the height of the bone cut with the Resection gauge.

NOTE

To determine if the tibial slide bar is perpendicular to the tibial cut, slide the universal handle onto the slide bar and use the alignment gauge to verify the alignment.

2 Combined tibial guide

Landmarks:

- See page 16

Assembly of the Combined System and resection height adjustment:

- Attach the Tibial slide bar and the Tibial resection guide (left or right) together onto the Tibial bracket. Tighten the Wheel for tibial bracket.
- Assemble the Malleolar clamp with the Extramedullary alignment guide and with the Tibial slide bar.
- Place the Malleolar clamp around the ankle and then place the Tibial bracket onto the intercondylar eminence.
- Set the rotational and sagittal alignments before impacting the tabs.
- Clip the Tibial stylus onto the Tibial resection guide (make sure the clip is fully engaged).
- Set the resection height by using the Tibial stylus to palpate either the:
 - healthy side (10 mm cut relative to the chosen point),
 - worn side (0 mm cut relative to the chosen point (exit level of the saw blade).
- For other resection heights, use the 2 mm markings on the Tibial slide bar.
- Check the bone cut height with the Resection gauge.



NOTE

To determine if the tibial slide bar is perpendicular to the tibial cut, slide the universal handle onto the slide bar and use the alignment gauge to verify the alignment.

3 Tibial resection

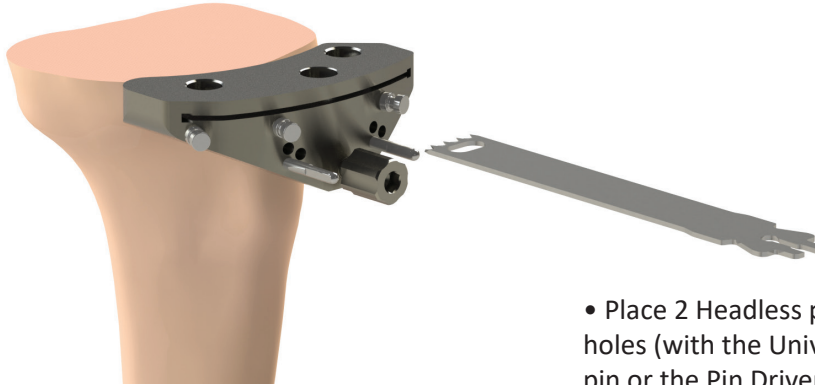

- Place 2 Headless pins length 80 mm in the 0 mm holes (with the Universal quick release adaptor for pin or the Pin Driver AO).
- The +2 and +4 markers will be used if a tibial recut is required.
- Place the « T » end of the Slap hammer into the opening on the Tibial bracket and then remove the entire intra- or extramedullary assembly.
- Place the Tibial resection guide flush with the anterior tibial cortex.
- Insert 3 Headed pins length 70 mm to stabilize the Tibial resection guide.
- Perform the tibial cut.
- Remove the Headed pins length 70 mm with the Pin extractor.
- Slide the Tibial resection guide off the pins, by leaving the pins in place in case a recut was necessary (the +2 and +4 holes will be used at that time).
- The Flat rasp can be used to flatten the tibial resection.

NOTE

Depending on the bone quality, a Long Drill bit, $\varnothing 3.2$ length 145 mm can be used to make the holes for the pins.

4 Extension and flexion gaps

- It is then possible to check gaps using a Spacer thickness 10 mm mounted on the Universal handle which may accommodate the Extramedullary alignment rods.
- Spacer thickness 2 mm and 4 mm for spacer may also be added to the Spacer thickness 10 mm to improve ligament tension.

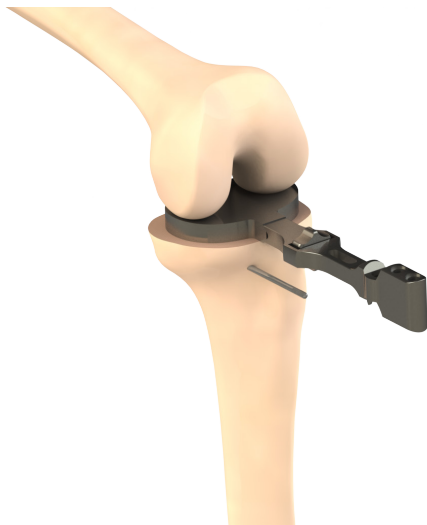
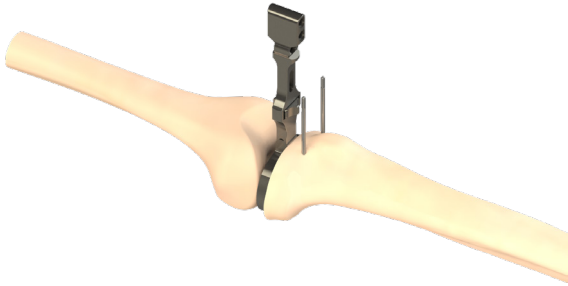

5 Femoral positioning

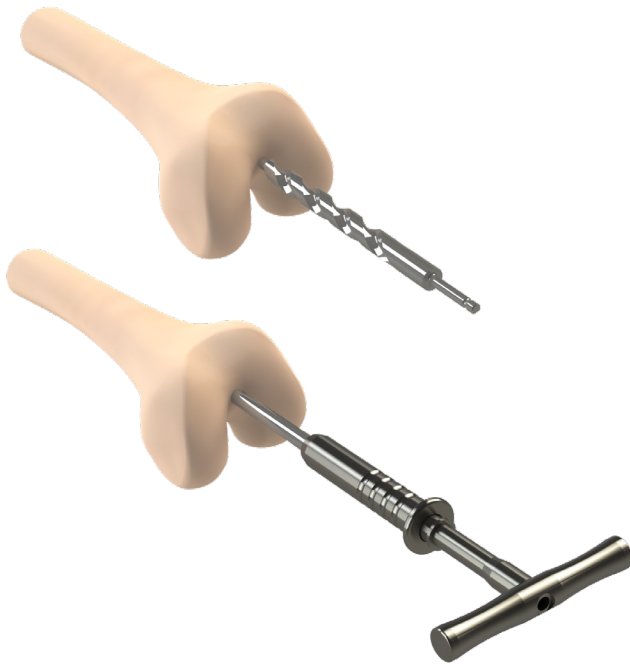

Intramedullary femoral aiming:

- Bend the knee at 90°
- Remove any peripheral osteophytes.
- Clear out tissues to access the anterior cortex.
- Based on the pre-operative planning, determine the entry point for the intramedullary canal and open the femoral canal with the Intramedullary drill bit.
- Assemble the Intramedullary rod length 400 mm on the T wrench, and insert it into the canal. The landmark located on the rod must always be visible.

NOTE

If the Intramedullary rod length 400 mm cannot be inserted use the Intramedullary rod length 250 mm.

NOTE

Push and turn the Anterior femoral stylus simultaneously to assemble it.

Femoral A/P measurement:

- Position the Sizing Guide with the Valgus Alignment Guide 5° (or 3°, 7°, 9°) corresponding to the operated side, on the Intramedullary rod.
- Ensure it is in contact with at least one of the distal condyles.
- Make sure the Posterior plate for sizing guide rests on the two posterior condyles.
- Place the Anterior femoral stylus on the anterior cortex, and move it side to side as needed.
- Use the H5 Screwdriver to tighten the side screw and set the anteroposterior size.
- Place the Spacer thickness 7 mm between the paddles of the Posterior plate for sizing guide (3 mm thick) and the tibial cut to simulate a 10 mm thick tibial cut.
- The Spacer thickness 2 mm (or 4mm) for spacer may be added to the Spacer thickness 7 mm to further refine the ligament tension.
- Evaluate the laxity with the knee flexed.

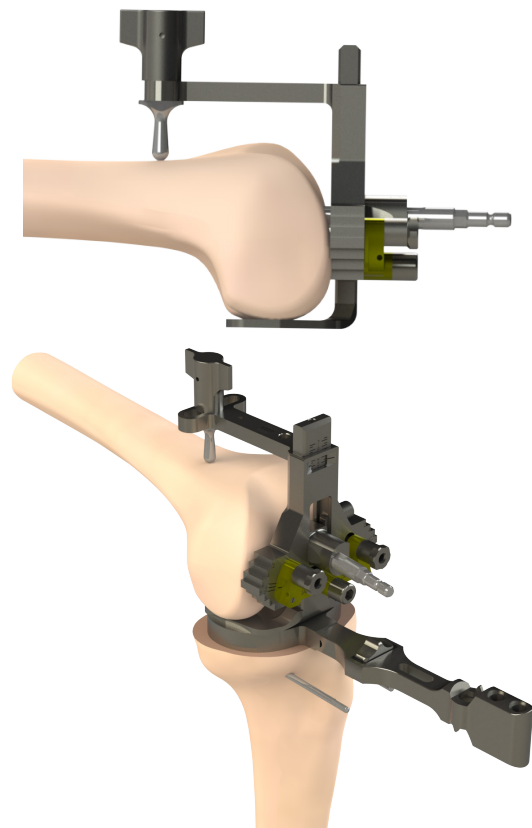

NOTE

For patients with a non-reducible flexion deformity, a distal femoral precut can be made (see page 39).

5 Femoral positioning

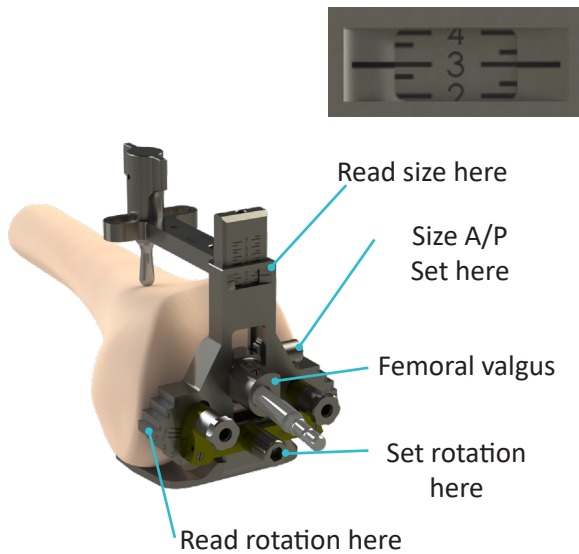

Femoral component size selection:

- Read the size from the markings.

Two scenarios may occur:

1 : You can read an exact size :

- The anterior and posterior reference points will be used simultaneously. The thickness of the bone cut will be equal to the thickness of the implant: 8 mm posteriorly.
- Tighten the lateral screw with the H5 Screwdriver.

2 : The reading is between two sizes:

- The next larger or smaller can be used with either the anterior or the posterior reference point. This is possible because of the 2.6 mm increment between sizes and the 6° anterior cut.

Example of reading between two sizes

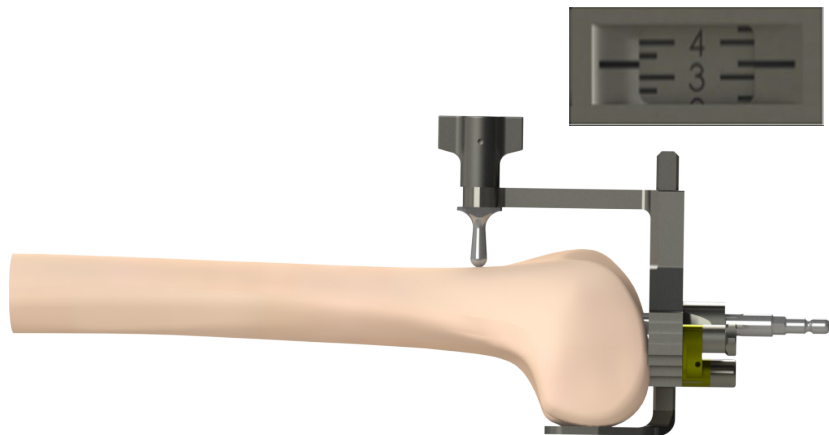

5 Femoral positioning

Example of reading between two sizes

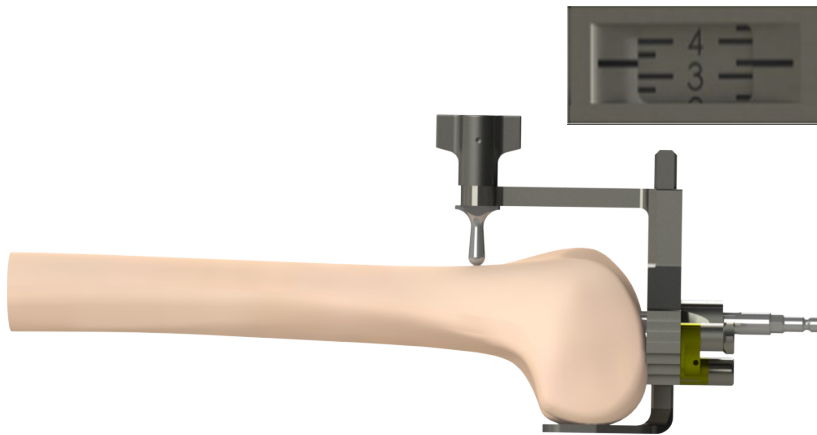

For an anterior reference point

- The Posterior plate for sizing guide must stay in contact with the posterior condyles.
- The Anterior femoral stylus must touch the anterior cortex.
- The measured gap (millimetres) is then factored into the posterior condyle cut.
- For example, in the scenario shown on the previous page, where the reading corresponds to **Size 3 + 1 mm** or **Size 4 – 2 mm**:
 - **Smaller size selected** = 9 mm posterior cut (for an 8 mm implant thickness)
Increases gap in flexion.
 - **Larger size selected** = 6 mm posterior cut (for an 8 mm implant thickness)
Increases gap in flexion.

For a posterior reference point

- Remove the Anterior femoral stylus, but leave the Posterior plate for sizing guide against the posterior condyles.
- Place the laser marking on the chosen size.
- Fully tighten the side screw with the H5 Screwdriver.
- The measured gap (millimetres) is then factored into the anterior cut.
- For example, in the scenario shown on the previous page, where the reading corresponds to **Size 3 + 1 mm** or **Size 4 – 2 mm**:
 - **Smaller size selected** = 8 mm posterior cut (for an 8 mm implant thickness)
Anterior cut will be 1 mm lower due to the 6° anterior cut.
Flexion gap is maintained and loads on patella are reduced.
 - **Larger size selected** = 8 mm posterior cut (for an 8 mm implant thickness)
Anterior cut will be 2 mm higher.
Flexion gap is maintained and loads on patella increase.

5 Femoral positioning

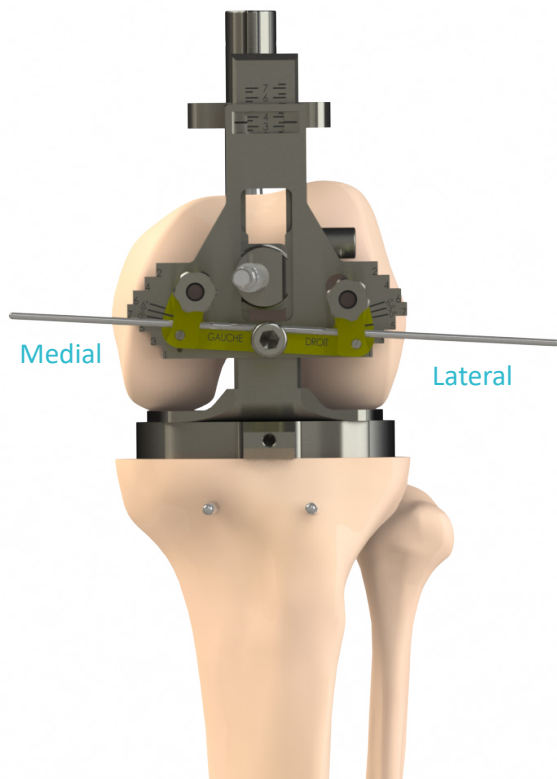

Setting the rotation:

- The rotation can be determined using various anatomical and/or ligament-based landmarks.
- Anatomical landmarks:
 - Trans-epicondylar axis (TEA): insert 2 Alignment Pin \varnothing 2 Length 150 mm on each side of the Sizing Guide to visualize the alignment with the TEA.
 - Posterior condylar axis,
 - Anteroposterior axis.
- Ligament-based landmarks:
 - A gap balancing simulator is available upon request (see page 38).
- Once the rotation (0° , 3° or 6°) has been determined, place the Drill guides for pin \varnothing 4 in the Sizing Guide at the appropriate locations for the operated side.
- Fully tighten the front screw with the H5 Screwdriver.

6 Femoral resections

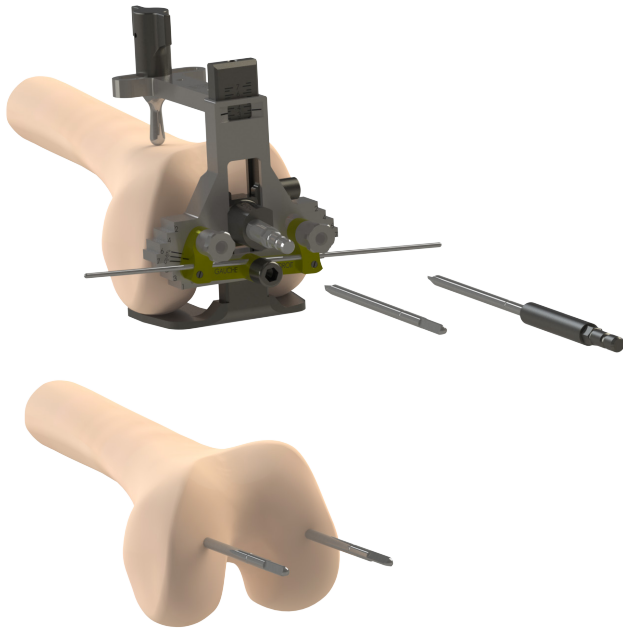

Pins insertion:

- Use the power tool to drive two Smooth Pins \varnothing 4 Length 90 mm or Threaded pins \varnothing 4 length 90 mm into the Drill Guides for pin \varnothing 4 placed on the Sizing Guide until the landmark is reached.
- Use the Universal quick release adaptor for pin or Pin Driver AO to connect the pins to the handpiece.
- Remove the two Drill Guides for pin \varnothing 4, the Intramedullary rod, and the Sizing Guide.

NOTE

The Universal quick release adaptor for pin can also be used with the T wrench.

Positioning of the 5-in-1 resection guide and cuts:

- Place the Femoral resection guide of the chosen size onto the pins.
- Make sure the guide touches at least one of the distal condyles.
- Position the Femoral resection guide stabilizer and secure it by tightening the Wheel for resection guide and using a Headless pin length 80 mm.
- Starting with the side that is touching the distal condyle, secure the Femoral resection guide with four Headed pins length 70 mm.
- Remove the two pins \varnothing 4 length 90 mm.
- Make the five cuts:
 - Anterior
 - Posterior
 - Anterior chamfer
 - Posterior chamfer
 - Distal
- Remove the Headed pins length 70 mm with the Pin extractor and then remove the Femoral resection guide.

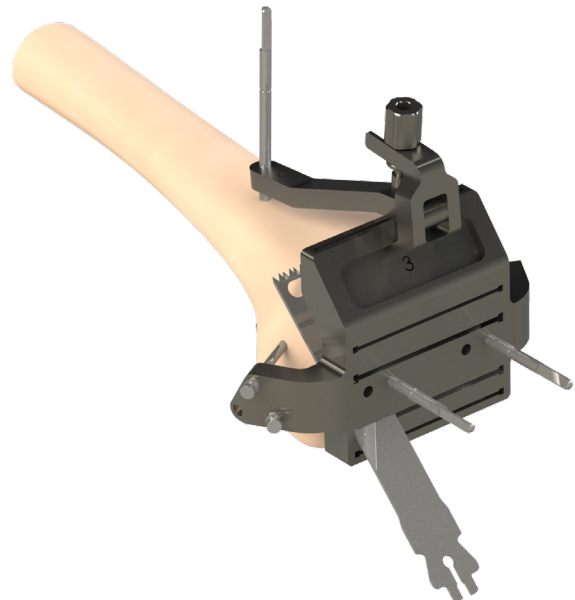

NOTE

Depending on the bone quality the Long Drill bit \varnothing 3.2 length 145 mm can be used to make the holes for the pins.

NOTE

MIS 5-in-1 resection guides are available upon request (see page 40).

7 Extension and flexion gaps

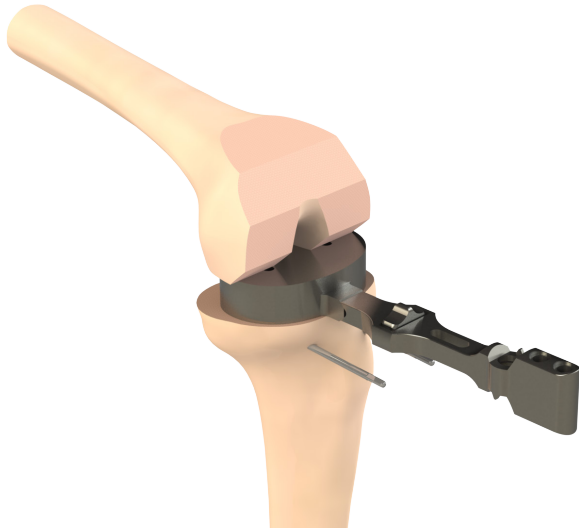

Gaps evaluation:

- The flexion and extension gaps can be verified with the Spacer thickness 18 mm (10 mm for the tibial cut + 8 mm for the femoral component).
- The Spacer thickness 2 mm for spacer (or 4 mm) may be added to the Spacer thickness 18 mm if necessary.

Various scenarios may be encountered:

Observation	Solution
Knee has acceptable gaps in flexion and extension	Determine insert height
Knee is tight in flexion and extension	Perform the tibial cut again to remove an additional 2, or 4 mm of bone; use the pins that were left in the tibia (see page 19)
Knee is tight in extension, but acceptable in flexion	Repeat the femoral cuts using the 4 mm or 6 mm blocks (see below)
Knee has acceptable gaps in extension, but is tight in flexion	Select a smaller femoral component and redo the cuts using the 8 mm block (see below)

8 Distal femoral recutting

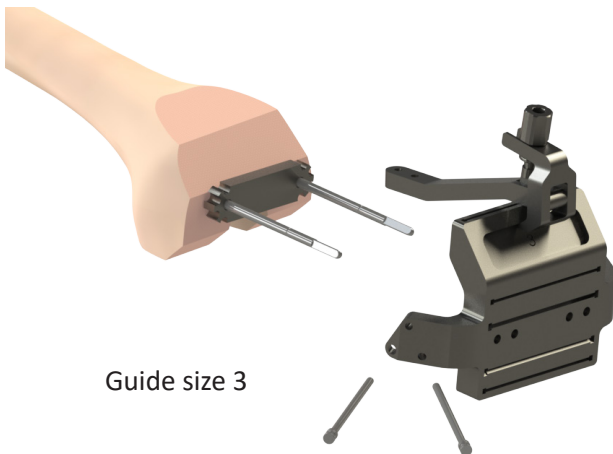

Guide size 3

- Reintroduce the two pins $\varnothing 4$ length 90 mm.
- Position the appropriate Femoral recutting wedge on these pins.
 - 6 mm : 2 mm re-cut
 - 4 mm : 4 mm re-cut
- Place the initial Femoral resection guide flush against the Femoral recutting wedge.
- Add the Femoral resection guide stabilizer .
- Secure it by placing two pins $\varnothing 4$ length 90 mm in the most posterior holes on the guide and two Headed pins length 70 mm in the most anterior holes (see drawing).
- Remove the two distal pins $\varnothing 4$ length 90 mm and the Femoral recutting wedge.
- Perform the cuts.

9 Changing sizes

Changing size :

- Reintroduce the two pins $\varnothing 4$ length 90 mm.
- Place the Femoral recutting wedge - 8 mm onto the two pins.
- Place a smaller Femoral resection guide flush against the Femoral recutting wedge.
- Add the Femoral resection guide stabilizer.
- Secure it by placing two pins $\varnothing 4$ length 90 mm in the most posterior holes on the guide and two Headed pins length 70 mm in the most anterior holes (see drawing).
- Remove the two distal pins $\varnothing 4$ length 90 mm and the Femoral recutting wedge.
- Perform the cuts.

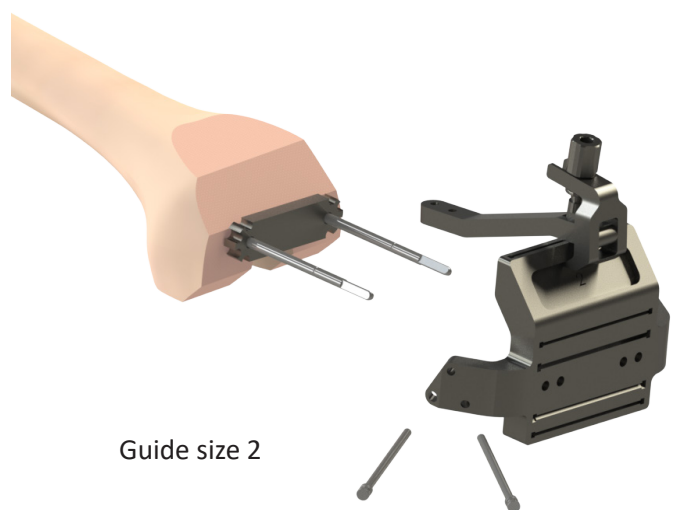

Guide size 2

10 Femoral preparation

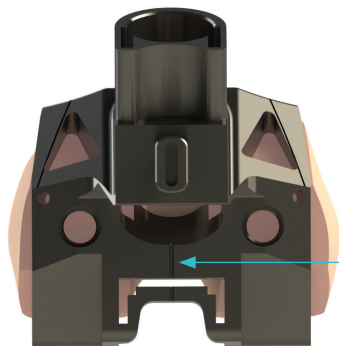
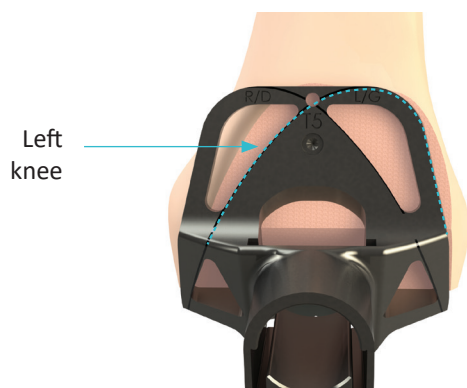
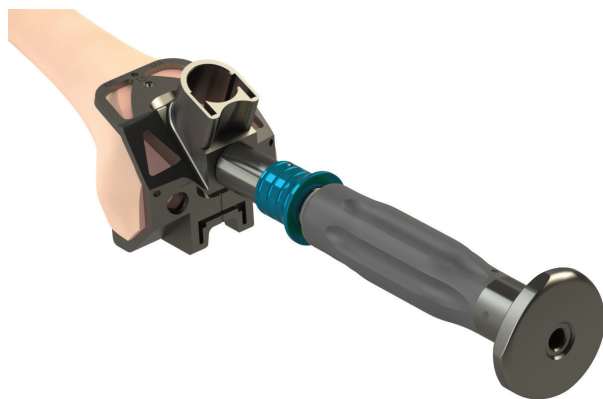

Femoral preparation guide placement:

- Choose the same size of Femoral preparation guide as the 4-in-1 resection guide used previously.
- Place the Universal handle on the oval clip by simultaneously pushing and turning the handle one-quarter turn.
- Place the Femoral preparation guide onto the femur. This guide has the same mediolateral dimensions as the final femoral component. Use the two windows on the anterior face to help position the guide:
 - the outer (lateral) side of the guide corresponds to the outer edge of the final femoral component
 - the inner (medial) side of the window corresponds to the inner edge of the final femoral component (see figure)
- The Femoral preparation guide can be centred in the medio-lateral direction by aligning the line at the centre of the guide over the posterior intercondylar notch.
- Secure the Femoral preparation guide with 3 Headed pins length 30 mm.
- Remove the Universal handle.

Femoral notch preparation:

- Select the same size of Notch reamer as the Femoral preparation guide.
- Push the Notch reamer into the Femoral preparation guide until it stops.

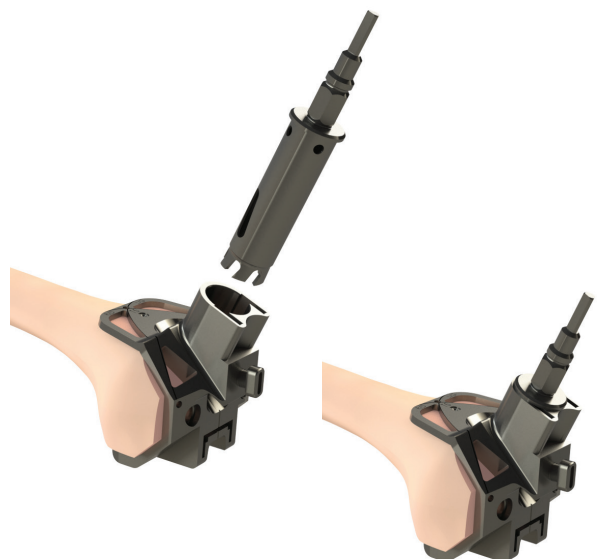

10 Femoral preparation



Femoral trochlea preparation:

- Select the Trochlea box chisel corresponding to the operated side and assemble it with the Universal handle.
- Prepare the trochlea by inserting the Trochlea box chisel into the Femoral preparation guide.

NOTE

Make sure the Trochlea box chisel is properly oriented from bottom to top.

Postero-stabilisation cam preparation:

- Assemble the L-shape chisel with the Universal handle.
- Prepare the posterior stabilization cam space by pushing the L-shape chisel into each side of the guide area. Impact the L-shape chisel until it reaches the line corresponding to the size of the Femoral preparation guide being used (guide entrance).
- Prepare the two holes for the pegs with the Drill for peg holes with stop.

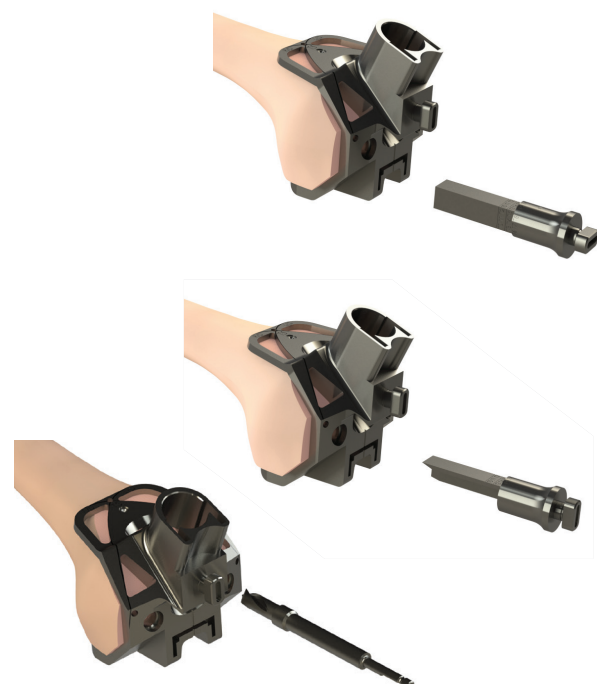

10 Femoral preparation



Final femoral preparation:

- To remove the bone ridge between the distal cut and reamed notch:
 - Select an Osteotome of the same size as the Femoral preparation guide
 - Push the Osteotome into each of the two slots on the outside of the reamer hole until it stops, make sure the « NOTCH SIDE » label faces the notch when pushing in the Osteotome
- Remove the 3 headed pins length 30 mm using the Pin extractor and extract the Femoral preparation guide using the Universal handle.

NOTE

If the Osteotome is difficult to pull out, place the T end of the Slap hammer into the hole.

11 Positioning of the trial femoral component

- Select the appropriate side and size of the ANATOMIC Trial femoral component posterior stabilized.
- Set up the 2 Trial pegs for trial femoral component on the trial femoral component, and assemble it on the Femoral component Holder.
- Impact the trial femoral component adjusting the medio-lateral position as needed.
- Finish impacting the trial femoral component using the Femoral component impactor on the Universal handle.
- Any posterior osteophytes can be removed using the Cutting gauge or Unicompartmental osteotome.

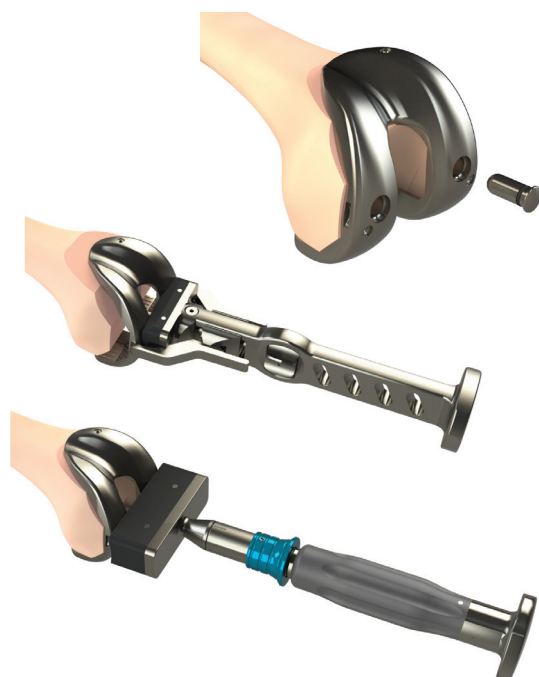

12 Tibial preparation



Placement of trial tibial baseplate:

- Determine the size of the ANATOMIC Trial baseplate posterior stabilized. The tibial baseplate can be the same, or one size larger or smaller than the size of the femoral component.
- Position the trial tibial baseplate onto the tibial cut. The Tibial baseplate handle can be used.
- Once the size has been selected, remove the Tibial baseplate handle, place the same size of ANATOMIC Trial fixed bearing insert, PS and reattach the Tibial baseplate handle. The lugs on the handle help secure the trial insert to the trial baseplate. In addition, the handle can be used with an Extramedullary alignment rod to verify the rotation, slope and perpendicular alignment of the tibial cut.

NOTE

Remove the 2 headless pins length 80 mm left in the tibia.

Trials:

- Put the assembled femoral and tibial trial components through a flexion / extension cycle to assess joint balance and allow the trial baseplate to seat itself in the appropriate rotation (the Tibial baseplate handle can be removed).
- Pick a different trial insert height if needed.
- Use electrocautery to mark the trial baseplate position on the tibia using the two lines on the trial baseplate.
- Remove the assembled tibial trial components and replace the baseplate (without the trial insert) using the marks made on the tibia as a guide.
- Secure the trial baseplate with two Headed pins length 30 mm.



12 Tibial preparation

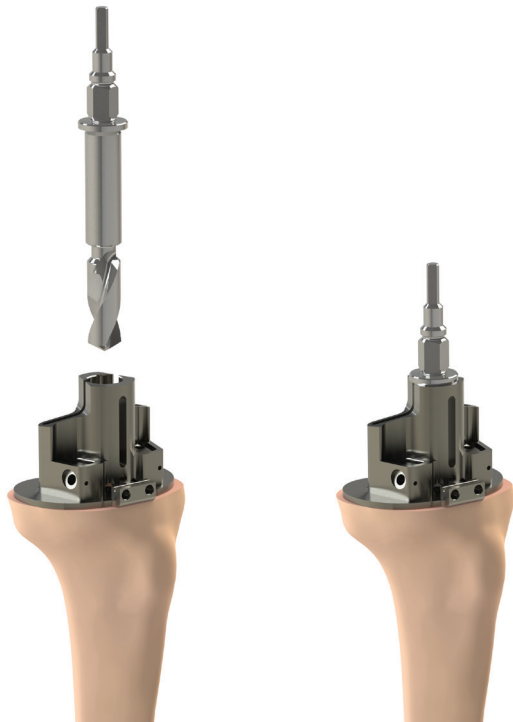

Keel preparation:

- Place the Guide for tibial fin punch onto the trial baseplate and verify that the sizes are compatible.
- Removable hand holds can be secured to the sides of the Guide for tibial fin punch to stabilise the entire assembly.
- With the power tool, drive the Reamer for tibial keel into the guide until it stops.

Fins preparation:

- Prepare the fins by pushing the appropriate size of the Tibial fin punch (assembled with the Universal handle) until it stops.
- Remove all the instruments using the Tibial baseplate handle and the Pin extractor.



13 Patella preparation: Patellar resection option



Patellar preparation:

- Use the Patellar Drilling Guide Ø30 or Ø33 and Ø36 to determine the size of patellar component needed. It is recommended to use the size that allows maximum bone coverage, without presenting a prosthetic overhang.
- Centre and impact the Patellar Drilling Guide.
- Make the 3 holes for the pegs with the Drill Bit for Resurfacing Patella.
- Place the Trial resurfacing patella of the same diameter using the Clamp for Locking Ring.
- Test the articulation in the trochlea.

Patellar implantation:

- Clean and dry the bone surface.
- Apply cement onto the implant.
- Position the implant on the cut.
- Tighten the implant using the Patellar Impaction clamp.
- Remove the excess of cement.
- Keep the clamp until the cement is dry.

Patellar preparation:

- Clear osteophytes.

Position the patellar Resection Clamp:

- Place the Patellar Resection Clamp, the two lugs are on the anterior side of the patella.
- With the clamp jaws open, bring the Patellar resection gauge in contact with the articular surface using the adjustment knob.
- Lock the clamp.
- Evaluate remaining bone.
- Push the saw blade into the slot to perform the cut.

NOTE

The thickness of the patellar implant is 8 mm for all the diameters and it is advisable to leave a remnant of 12 mm of residual bone.

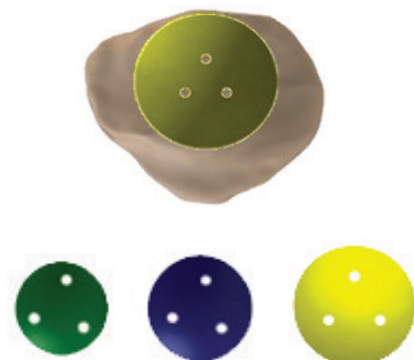

13 Patella preparation: Patellar reaming option



Patellar preparation:

- Clear osteophytes.

Position the Patella Reamer Clamp:

- Centre the Trial inset patellar - cemented \varnothing 23 mm – Plastic (or \varnothing 26, or \varnothing 29) on the articular surface of the native patella by centering it on the patellar crest.
- The appropriate size (\varnothing 23, 26 or 29 mm) is determined based on the following criteria :
 - Superior-to-inferior length of the articular surface
 - Width of the patella’s medial articular facet
- The size must be as large as possible being slightly smaller (by about 2 mm) than the superior-to-inferior length of the articular surface and must be slightly inside the medial edge of the medial articular facet.
- Assemble the Patella Reamer Surfacing Guide corresponding to the chosen patellar implant size onto the Patella Reamer Clamp and lock it.
- Position the clamp. The inferior jaw on the Patella Reamer Clamp must rest against the anterior side of the patella. The clamp must rest against at least one of the patella’s two articular facets.
- Use the thumb knob to tighten the Patella Reamer Clamp.
- Assemble the Reamer for inset cementless patellar of the same size as the chosen clamp onto the power tool.
- Ream the patella until the stop is reached.

Trials:

- Assemble the Patellar Reamer Impaction Clamp onto the Patella Reamer Clamp and lock it.
- Use it to place the Trial inset patellar - cemented — Plastic of the selected size into the native patella.
- Test the patella tracking.

Patellar implantation:

- Clean and dry the bone surface.
- Use the Patellar Reamer Impaction Clamp assemble on the Patella Reamer Clamp to insert the chosen patellar component.

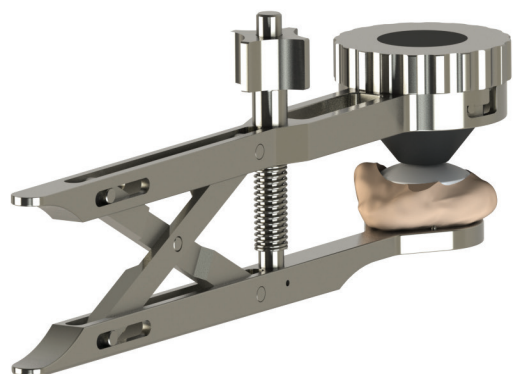

14 Definitive implants

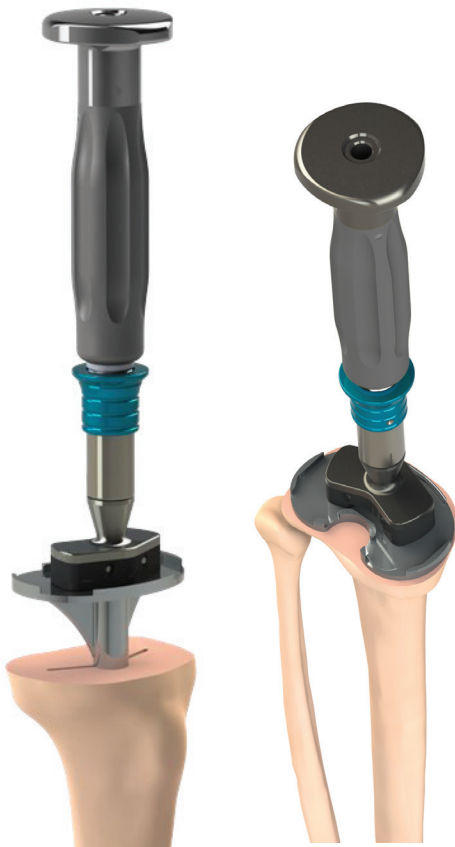

Insertion of chosen tibial baseplate:

- Use the Tibial stem wrench to screw the distal peg into the tibial baseplate (cemented or cementless).
- Wash and dry bone surfaces and the joint space.
- For the cemented version, apply a layer of cement to the bone, the implant surface or to both.
- Position the tibial baseplate and impact it using the Baseplate impactor mounted on the Universal handle.
- For the cemented version, remove any excess cement taking care to limit the movement of the components while the cement is curing.

Insertion of chosen insert:

- At this point in the procedure, trials can still be performed with a trial insert and the chosen tibial baseplate.
- Hyperflex the knee.
- Slide the insert onto the lateral baseplate rails, and then impact its anterior edge using the Tibial impactor.



NOTE

The Tibial impactor has to be slightly anteriorly inclined to ensure a better impaction of the insert.

14 Definitive implants

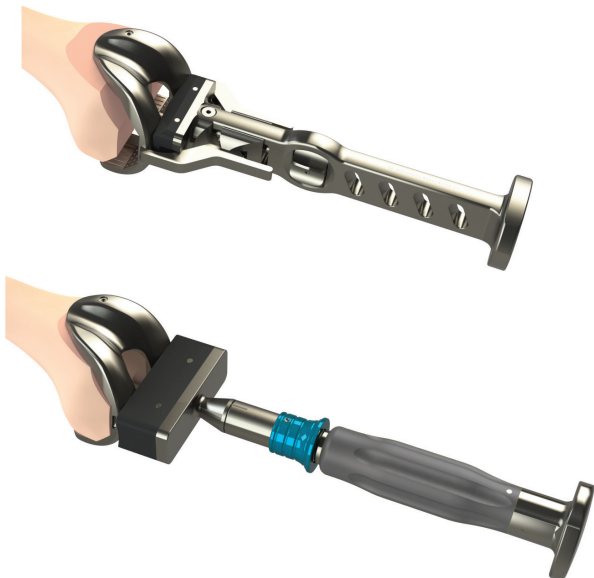

Insertion of chosen femoral component:

- Assemble the chosen femoral component (cemented or cementless) with the Femoral component holder.
- For the cemented version, apply a layer of cement to the bone, the implant surface or to both.
- Place the femoral component onto the femoral cuts, make sure it is aligned precisely, and then impact it.
- Remove the Femoral component holder.
- Finish impacting the component using the Femoral component impactor and Universal handle.
- For the cemented version, remove any excess cement taking care to limit the movement of the components while the cement is curing.
- Reduce the femoral component onto the insert.

15 Implants extraction



Tibial extraction:

- Remove the tibial insert with an osteotome.
- Assemble the Tibial baseplate extractor with the Universal handle.
- Screw them into the tibial baseplate.
- Gradually extract the component by tapping under the anvil.

NOTE

The Slap hammer can be assembled with the Universal handle to make the extraction easier.

Femoral extraction :

- Assemble the Femoral component holder on the femoral component.
- Gradually extract the component by tapping under the anvil.

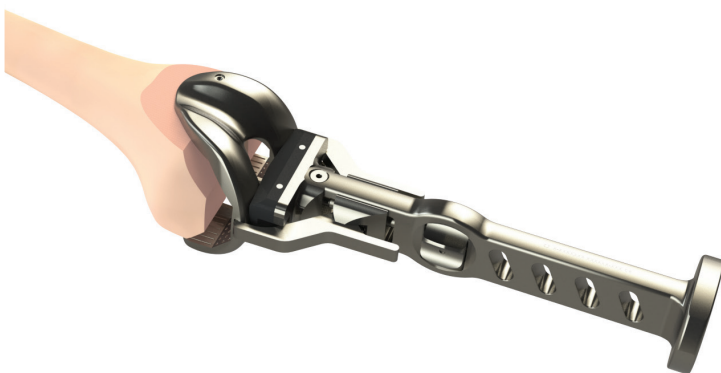

Option: Simulated gap balancing before femoral cuts

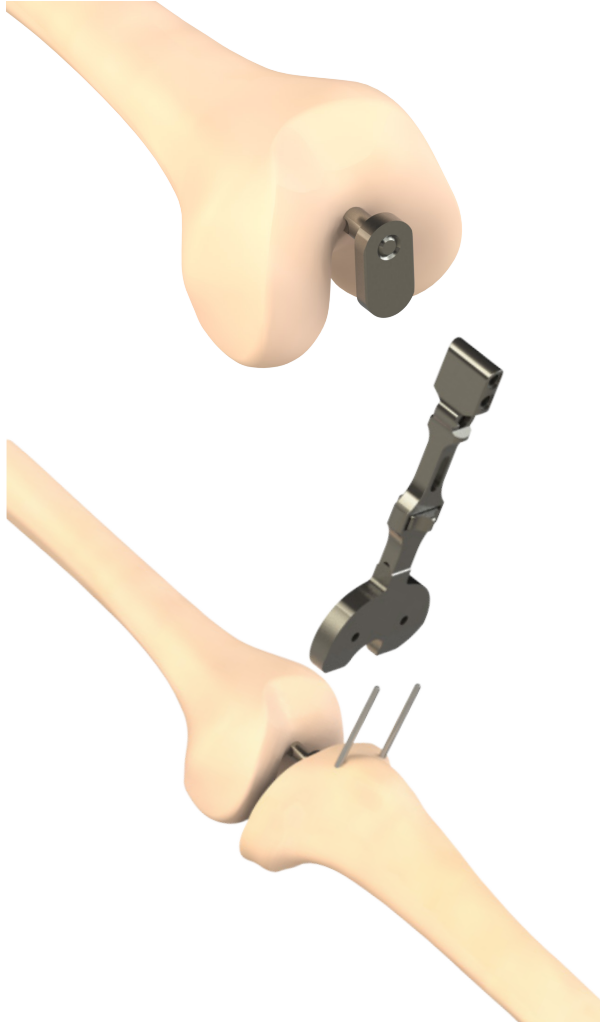

- Locate the entry point of the femoral medullary canal, and drill a hole into it using Intramedullary drill bit.
- Assemble the Impactor-extractor tip for intramedullary balancing simulator stem on the Slap hammer.
- Use it to insert the Intramedullary balancing simulator rod (or the Short intramedullary balancing simulator stem) while making sure the anteroposterior (A/P) position is correct. Two Extension spacer - Left (or Right) angle 5° (or 7°) Height 10 mm are available .

Before the cuts are made, the following actions can be performed with the knee extended :

- Simulate gap balancing with 5° or 7° valgus as if the femoral cuts had been made.
- Balance as needed.
- Validate the Valgus Alignment Guide.

NOTE

This gap balancing simulator is optional.

- Place the Sizing Guide and the Valgus Alignment Guide 5° or 7° validated during the extension phase, on the Intramedullary balancing simulator rod.

Same surgical technique as femoral step.

Before the cuts are made, the following can be performed with the knee flexed :

- Simulate gap balancing with 0°, 3° or 6° external rotation by using the Flexion spacer - Right (or Left) angle 3° (or 6°) Height 7 mm.
- Once the rotation has been determined, fully tighten the front screw with the H5 Screwdriver.

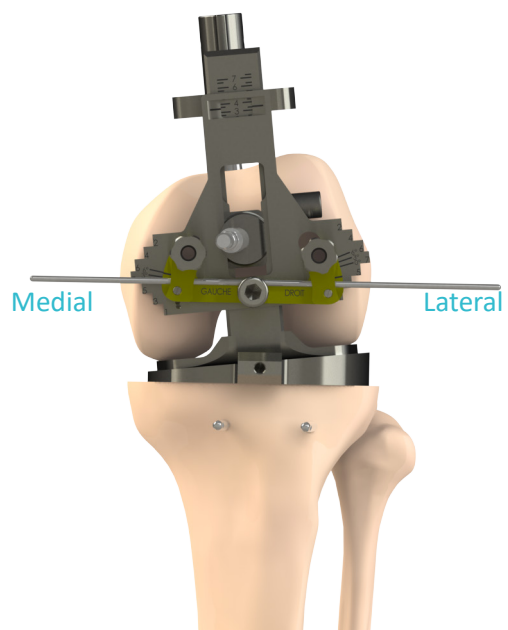

Option: Distal femoral pre-cut

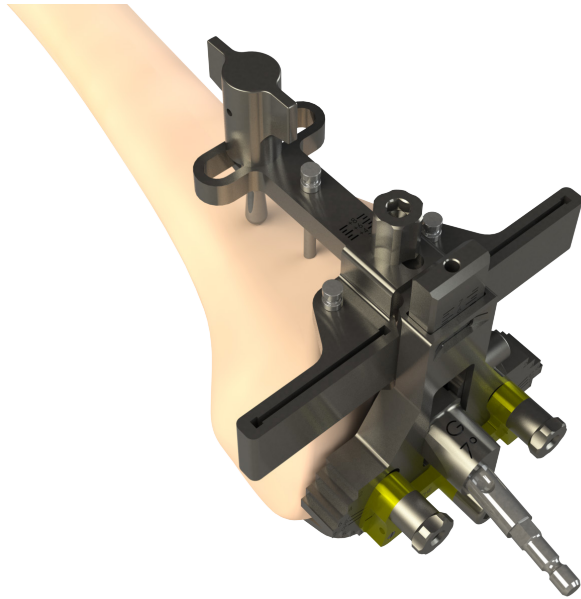

For patients with a significant pre-operative flexion deformity, a 2 or 4 mm distal femoral pre-cut can be made:

- Secure the Additional distal resection guide onto the front part of the Sizing Guide and transfer the chosen value.
- Insert two Headed pins length 70 mm.
- Perform the distal femoral pre-cut.
- Once the cut has been made, set the Sizing Guide so it touches the distal condyles again.

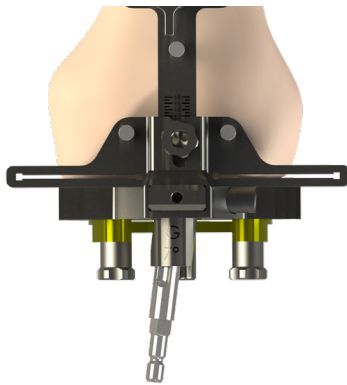

Option: MIS femoral resection guides

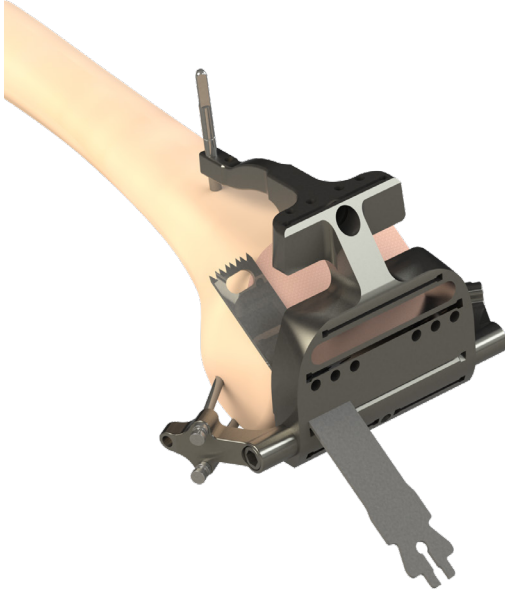

IMA femoral resection guides are available upon request to perform the femoral cuts.

- With the H5 Screwdriver, secure the Femoral resection guide stabilizer and at least one of the Bracket for MIS 5 in 1 revision femoral resection guide onto the IMA Femoral resection guide of the selected size.
- Place the IMA Femoral resection guide on the pins $\varnothing 4$ length 90 mm.
- Make sure the guide touches at least one of the distal condyles.
- To secure the assembly, put two Headed pins length 70 mm into the lateral Brackets for MIS 5 in 1 revision femoral resection guide and one Headless pin length 80 mm into the anterior stabilizer. A 90 mm Smooth Pin $\varnothing 4$ Length 90 mm can be used in the notch instead of the anterior stabilizer.
- Remove the pins and perform the cuts:
 - Anterior
 - Posterior
 - Anterior chamfer
 - Posterior chamfer
 - Distal
- Remove the Headed pins length 70 mm with the Pin extractor, and then remove the IMA Femoral resection guide.

NOTE

If desired, remove one pin and perform five half-cuts. Replace this pin and remove the other one to finish the cuts.



Instrumentation

The anatomic conventional instrumentation* consists of 6 trays:

- Instrumentation set for [ANATOMIC Postero-stabilized : Common Set](#)
- Instrumentation set for [ANATOMIC PS Posterior stabilized Resection Tibial Set](#)
- Instrumentation set for [ANATOMIC Postero-stabilized : Tibial Trial](#)
- Instrumentation set for [SCORE 5-in-1 Femoral Resection](#)
- Instrumentation set for [ANATOMIC Postero-stabilized : Femoral Preparation](#)
- Instrumentation set for [ANATOMIC Postero-stabilized : Femoral Trial](#)

And either of:

- Instrumentation set for [SCORE Primary - Patella Resection Set \(Conventional\)](#)
- Instrumentation set for [SCORE patellar set - Reaming Patella Set](#)

In addition:

- Instrumentation set for [ANATOMIC Postero-stabilized - Size 0 and Size 8 - 5 in 1](#)
- Instrumentation set for [SCORE TKA MIS cutting guides](#)
- Instrumentation set for [Gap Balancing Simulation](#)
- Instrumentation set for [ANATOMIC PS—Tibial Revision Set](#) (Cf Conventional ST anatomic Tibial Revision TO.G.004 and Conventional ST anatomic 4T Tibial Revision TO.G.005)
- Sterile large saw blades
- Sterile medium saw blades

*Not all devices presented in this Surgical Technique may be registered in your country. Please contact your Amplitude Sales Representative for availability.



Instrumentation

Anatomic: Postero-stabilized common set

2-02999124

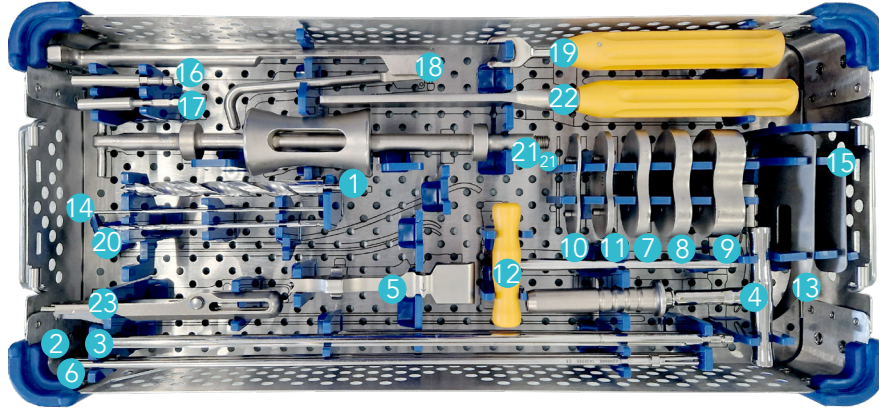

Item	Name	Product No.	Qty
1	Intramedullary drill bit	2-0200100	1
2	Intramedullary rod length 250 mm	2-0200200	1
3	Intramedullary rod length 400 mm	2-0200300	1
4	T wrench	2-0200400	1
5	Universal handle	2-0216400	1
6	Extramedullary alignment rod	2-0200600	1
7	Spacer thickness 7 mm	2-0200707	1
8	Spacer thickness 10 mm	2-0200710	1
9	Spacer thickness 18 mm	2-0200718	1
10	Spacer thickness 2 mm for spacer	2-0207002	1
11	Spacer thickness 4 mm for spacer	2-0207004	1
12	H5 Screwdriver	2-0200800	1
13	Resection gauge	2-0204500	1
14	Alignment Pin Ø 2 Length 150 mm	2-0103000	2
15	Alignment gauge	2-0206300	1
16	Universal quick release adaptor for pin	2-0201100	1
17	Pin Driver AO	2-0201200	1
18	Pin extractor	2-0201500	1
19	Tibial stem Wrench	2-0205500	1
20	Long Drill bit Ø3.2 length 145 mm	2-0102400	1
21	Slap hammer	2-0206900	1
22	Flat rasp	2-0206800	1
23	Tibial baseplate handle	2-0223500	1

Instrumentation

Anatomic: PS Posterior stabilized Tibial resection set

2-0299979

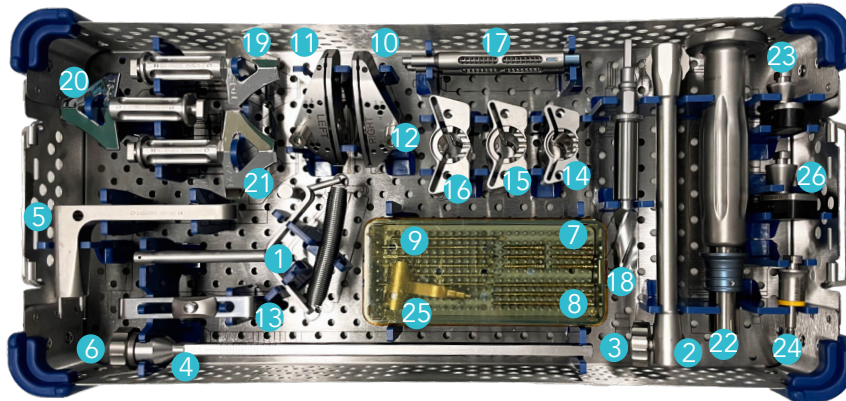

Item	Name	Product No.	Qty
1	Malleolar clamp	2-0201600	1
2	Extramedullary alignment guide	2-0201700	1
3	Wheel for extramedullary Alignment column	2-0201800	2
4	Tibial slide bar	2-0201900	1
5	Tibial bracket	2-0202000	1
6	Wheel for tibial bracket	2-0202100	1
7	Headed pin length 30 mm	2-0201301	6
8	Headed pin length 70 mm	2-0201302	3
9	Headless pin length 80 mm	2-0201400	6
10	Tibial resection guide RIGHT	2-0202200	1
11	Tibial resection guide LEFT	2-0202300	1
12	Wheel for resection guide	2-0203800	1
13	Tibial stylus	2-0202400	1
14	Guide for tibial fin punch Size 0-1-2	2-0230801	1
15	Guide for tibial fin punch Size 3-4-5	2-0230802	1
16	Guide for tibial fin punch Size 6-7-8	2-0230803	1
17	Removable hand holds	2-0226500	1
18	Reamer for tibial keel	2-0231600	1
19	Tibial fin punch size 0-1-2	2-0230901	1
20	Tibial fin punch size 3-4-5	2-0230902	1
21	Tibial fin punch size 6-7-8	2-0230903	1
22	Universal handle	2-0232100	1
23	Tibial impactor	2-0231900	1
24	Tibial baseplate extractor	2-0231800	1
25	Reference body support for tibial baseplate handle*	2-0223600	1
26	Baseplate impactor	2-0233400	1

* Not use in this surgical technique. Please refer to appropriate CAS 5 in 1 Surgical Technique for its description.



Instrumentation

Anatomic: Postero-stabilized tibial trials

2-02999124



Item	Name	Product No.	Qty
1	ANATOMIC Trial baseplate posterior stabilized Size 1	2-0231001	1
2	ANATOMIC Trial baseplate posterior stabilized Size 2	2-0231002	1
3	ANATOMIC Trial baseplate posterior stabilized Size 3	2-0231003	1
4	ANATOMIC Trial baseplate posterior stabilized Size 4	2-0231004	1
5	ANATOMIC Trial baseplate posterior stabilized Size 5	2-0231005	1
6	ANATOMIC Trial baseplate posterior stabilized Size 6	2-0231006	1
7	ANATOMIC Trial baseplate posterior stabilized Size 7	2-0231007	1
8	ANATOMIC Trial fixed bearing insert, PS – Size 1, Height 10	2-0230610	1
8	ANATOMIC Trial fixed bearing insert, PS – Size 1, Height 12	2-0230611	1
8	ANATOMIC Trial fixed bearing insert, PS – Size 1, Height 14	2-0230612	1
8	ANATOMIC Trial fixed bearing insert, PS – Size 1, Height 16	2-0230613	1
8	ANATOMIC Trial fixed bearing insert, PS – Size 1, Height 18	2-0230614	1
8	ANATOMIC Trial fixed bearing insert, PS – Size 1, Height 20	2-0230615	1
9	ANATOMIC Trial fixed bearing insert, PS – Size 2, Height 10	2-0230620	1
9	ANATOMIC Trial fixed bearing insert, PS – Size 2, Height 12	2-0230621	1
9	ANATOMIC Trial fixed bearing insert, PS – Size 2, Height 14	2-0230622	1
9	ANATOMIC Trial fixed bearing insert, PS – Size 2, Height 16	2-0230623	1
9	ANATOMIC Trial fixed bearing insert, PS – Size 2, Height 18	2-0230624	1
9	ANATOMIC Trial fixed bearing insert, PS – Size 2, Height 20	2-0230625	1
10	ANATOMIC Trial fixed bearing insert, PS – Size 3, Height 10	2-0230630	1
10	ANATOMIC Trial fixed bearing insert, PS – Size 3, Height 12	2-0230631	1
10	ANATOMIC Trial fixed bearing insert, PS – Size 3, Height 13	2-0230632	1
10	ANATOMIC Trial fixed bearing insert, PS – Size 3, Height 14	2-0230633	1
10	ANATOMIC Trial fixed bearing insert, PS – Size 3, Height 16	2-0230634	1
10	ANATOMIC Trial fixed bearing insert, PS – Size 3, Height 20	2-0230635	1



Instrumentation

Anatomic: Postero-stabilized tibial trials

2-02999124



Item	Name	Product No.	Qty
11	ANATOMIC Trial fixed bearing insert, PS – Size 4, Height 10	2-0230640	1
11	ANATOMIC Trial fixed bearing insert, PS – Size 4, Height 12	2-0230641	1
11	ANATOMIC Trial fixed bearing insert, PS – Size 4, Height 14	2-0230642	1
11	ANATOMIC Trial fixed bearing insert, PS – Size 4, Height 16	2-0230643	1
11	ANATOMIC Trial fixed bearing insert, PS – Size 4, Height 18	2-0230644	1
12	ANATOMIC Trial fixed bearing insert, PS – Size 4, Height 20	2-0230645	1
12	ANATOMIC Trial fixed bearing insert, PS – Size 5, Height 10	2-0230650	1
12	ANATOMIC Trial fixed bearing insert, PS – Size 5, Height 12	2-0230651	1
12	ANATOMIC Trial fixed bearing insert, PS – Size 5, Height 14	2-0230652	1
12	ANATOMIC Trial fixed bearing insert, PS – Size 5, Height 16	2-0230653	1
12	ANATOMIC Trial fixed bearing insert, PS – Size 5, Height 18	2-0230654	1
12	ANATOMIC Trial fixed bearing insert, PS – Size 5, Height 20	2-0230655	1
13	ANATOMIC Trial fixed bearing insert, PS – Size 6, Height 10	2-0230660	1
13	ANATOMIC Trial fixed bearing insert, PS – Size 6, Height 12	2-0230661	1
13	ANATOMIC Trial fixed bearing insert, PS – Size 6, Height 14	2-0230662	1
13	ANATOMIC Trial fixed bearing insert, PS – Size 6, Height 16	2-0230663	1
13	ANATOMIC Trial fixed bearing insert, PS – Size 6, Height 18	2-0230664	1
13	ANATOMIC Trial fixed bearing insert, PS – Size 6, Height 20	2-0230665	1
14	ANATOMIC Trial fixed bearing insert, PS – Size 7, Height 10	2-0230670	1
14	ANATOMIC Trial fixed bearing insert, PS – Size 7, Height 12	2-0230671	1
14	ANATOMIC Trial fixed bearing insert, PS – Size 7, Height 14	2-0230672	1
14	ANATOMIC Trial fixed bearing insert, PS – Size 7, Height 16	2-0230673	1
14	ANATOMIC Trial fixed bearing insert, PS – Size 7, Height 18	2-0230674	1
14	ANATOMIC Trial fixed bearing insert, PS – Size 7, Height 20	2-0230675	1

Instrumentation

5 in 1 Femoral resection

2-029944

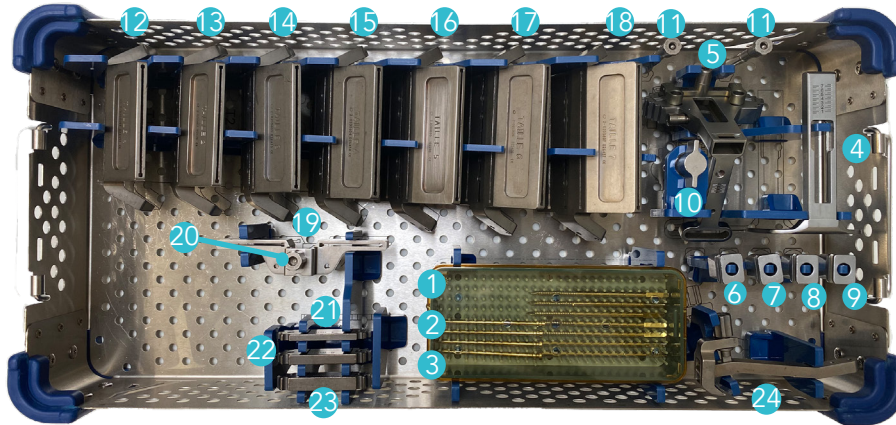

Item	Name	Product No.	Qty
1	Threaded pin Ø4 length 90 mm	2-0200901	5
2	Smooth Pin Ø 4 Length 90 mm	2-0201000	2
3	Headed pin length 70 mm	2-0201302	4
4	Posterior plate for sizing guide	2-0203100	1
5	Sizing Guide	2-0203200	1
6	Valgus Alignment Guide 3°	2-0203303	1
7	Valgus Alignment Guide 5°	2-0203305	1
8	Valgus Alignment Guide 7°	2-0203307	1
9	Valgus Alignment Guide 9°	2-0203309	1
10	Anterior femoral stylus	2-0203400	1
11	Drill guide for pin Ø 4	2-0203500	2
12	Femoral resection guide size 1	2-0203601	1
13	Femoral resection guide size 2	2-0203602	1
14	Femoral resection guide size 3	2-0203603	1
15	Femoral resection guide size 4	2-0203604	1
16	Femoral resection guide size 5	2-0203605	1
17	Femoral resection guide size 6	2-0203606	1
18	Femoral resection guide size 7	2-0203607	1
19	Additional distal resection guide	2-0203700	1
20	Wheel for resection guide	2-0203800	1
21	Femoral recutting wedge - 4 mm	2-0206004	1
22	Femoral recutting wedge - 6 mm	2-0206006	1
23	Femoral recutting wedge - 8 mm	2-0206008	1
24	Femoral resection guide stabilizer	2-0209900	1

Instrumentation

ANATOMIC: Postero-stabilized Femoral preparation

2-02999124

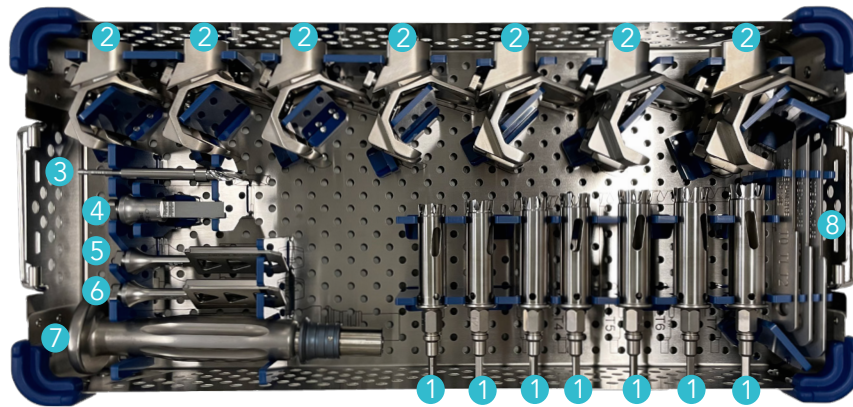

Item	Name	Product No.	Qty
1	Notch reamer Size 1	2-0231301	1
1	Notch reamer Size 2	2-0231302	1
1	Notch reamer Size 3	2-0231303	1
1	Notch reamer Size 4	2-0231304	1
1	Notch reamer Size 5	2-0231305	1
1	Notch reamer Size 6	2-0231306	1
1	Notch reamer Size 7	2-0231307	1
2	Femoral preparation guide Size 1	2-0230701	1
2	Femoral preparation guide Size 2	2-0230702	1
2	Femoral preparation guide Size 3	2-0230703	1
2	Femoral preparation guide Size 4	2-0230704	1
2	Femoral preparation guide Size 5	2-0230705	1
2	Femoral preparation guide Size 6	2-0230706	1
2	Femoral preparation guide Size 7	2-0230707	1
3	Drill for peg holes	2-0204000	1
4	L-shape chisel	2-0231700	1
5	Right Trochlea box chisel	2-0231400	1
6	Left Trochlea box chisel	2-0231500	1
7	Universal handle	2-0232100	1
8	Osteotome Size 0-1-2	2-0233700	1
8	Osteotome Size 3-4-5	2-0233701	1
8	Osteotome Size 6-7-8	2-0233702	1

Instrumentation

ANATOMIC: Postero-stabilized Femoral trial

2-02999124

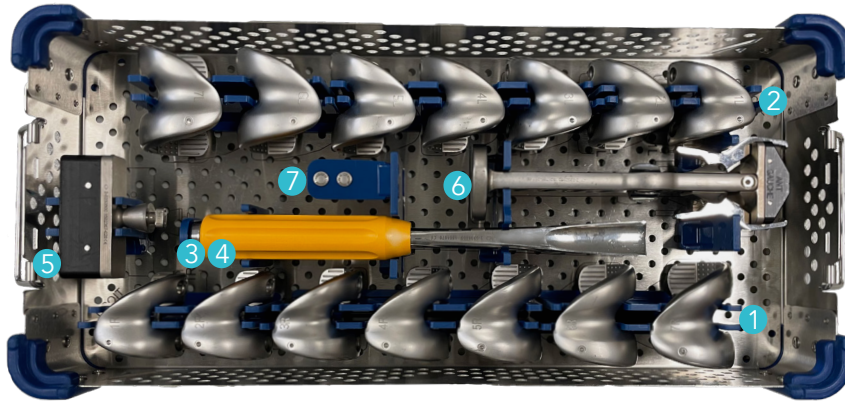

Item	Name	Product No.	Qty
1	ANATOMIC Trial femoral component posterior stabilized right Size 1	2-0231101	1
1	ANATOMIC Trial femoral component posterior stabilized right Size 2	2-0231102	1
1	ANATOMIC Trial femoral component posterior stabilized right Size 3	2-0231103	1
1	ANATOMIC Trial femoral component posterior stabilized right Size 4	2-0231104	1
1	ANATOMIC Trial femoral component posterior stabilized right Size 5	2-0231105	1
1	ANATOMIC Trial femoral component posterior stabilized right Size 6	2-0231106	1
1	ANATOMIC Trial femoral component posterior stabilized right Size 7	2-0231107	1
2	ANATOMIC Trial femoral component posterior stabilized left Size 1	2-0231201	1
2	ANATOMIC Trial femoral component posterior stabilized left Size 2	2-0231202	1
2	ANATOMIC Trial femoral component posterior stabilized left Size 3	2-0231203	1
2	ANATOMIC Trial femoral component posterior stabilized left Size 4	2-0231204	1
2	ANATOMIC Trial femoral component posterior stabilized left Size 5	2-0231205	1
2	ANATOMIC Trial femoral component posterior stabilized left Size 6	2-0231206	1
2	ANATOMIC Trial femoral component posterior stabilized left Size 7	2-0231207	1
3	Cutting gauge	2-0206500	1
4	Unicompartmental osteotome	2-0221500	1
5	Femoral component impactor	2-0233500	1
6	Femoral component holder	2-0232000	1
7	Trial peg for trial femoral component	2-0233300	2

Instrumentation

SCORE Primary: Patella resection set (conventional)

2-02999132

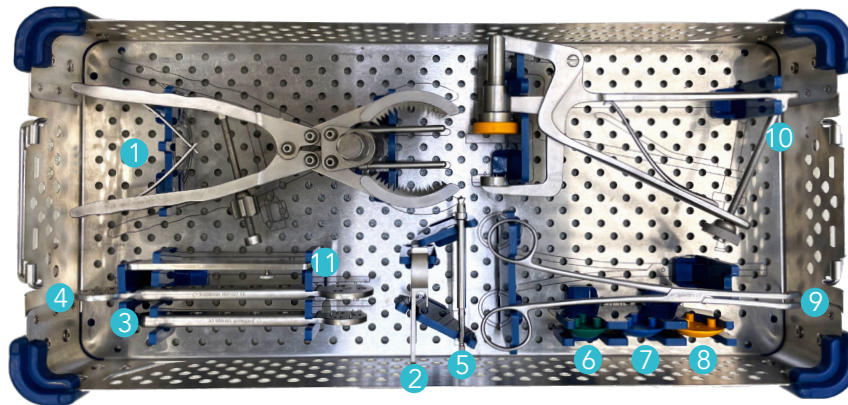

Item	Name	Product No.	Qty
1	Patellar Resection Clamp	2-0206700	1
2	Patellar resection gauge	2-0208400	1
3	Patellar Drilling Guide Ø30	2-0204900	1
4	Patellar Drilling Guide Ø33 and Ø36	2-0205000	1
5	Drill Bit for Resurfacing Patella	2-0205100	1
6	Trial resurfacing patella Ø 30	2-0205330	1
7	Trial resurfacing patella Ø 33	2-0205333	1
8	Trial resurfacing patella Ø 36	2-0205336	1
9	Clamp for Locking Ring	2-0104600	1
10	Patellar Impaction Clamp	2-0206100	1

Instrumentation

SCORE Patella set: Patella reaming

2-0299917

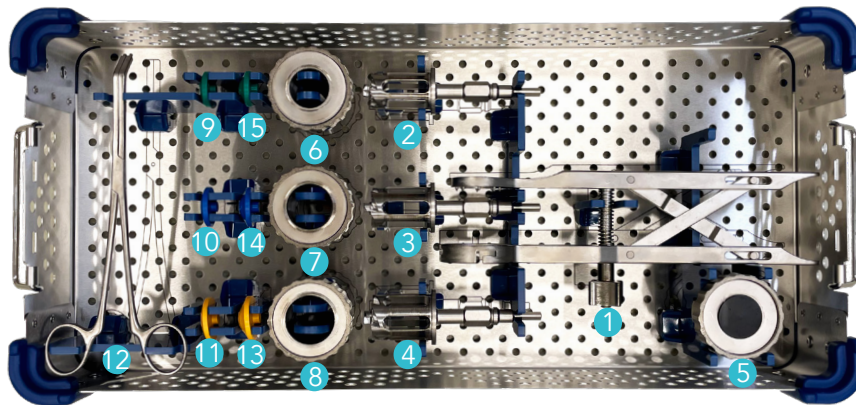

Item	Name	Product No.	Qty
1	Patella Reamer Clamp	2-0216600	1
2	Reamer for inset cementless patellar Ø 23	2-0216523	1
3	Reamer for inset cementless patellar Ø 26	2-0216526	1
4	Reamer for inset cementless patellar Ø 29	2-0216529	1
5	Patellar Reamer Impaction Clamp	2-0216800	1
6	Patella Reamer Surfacing Guides Ø 23	2-0216723	1
7	Patella Reamer Surfacing Guides Ø 26	2-0216726	1
8	Patella Reamer Surfacing Guides Ø 29	2-0216729	1
9	Trial Inset Patellar - Cemented Ø 23—Plastic	2-0205223	1
10	Trial Inset Patellar - Cemented Ø 26—Plastic	2-0205226	1
11	Trial Inset Patellar - Cemented Ø 29—Plastic	2-0205229	1
12	Clamp for Locking Ring	2-0104600	1
13	Trial Inset Patellar - Cementless Ø 29 —Plastic	2-0216929	1
14	Trial Inset Patellar - Cementless Ø 26 —Plastic	2-0216926	1
15	Trial Inset Patellar - Cementless Ø 23 —Plastic	2-0216923	1

Instrumentation

ANATOMIC PS - Optionnal set: Size 0 and size 8 - 5 in 1

2-0299958

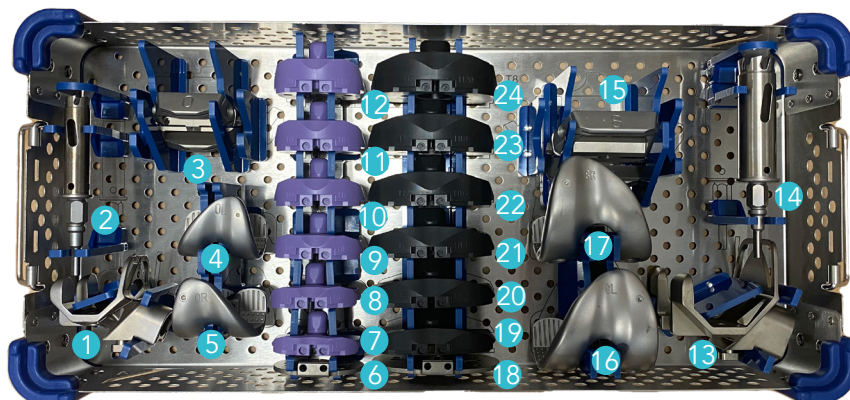

Item	Name	Product No.	Qty
1	Femoral preparation guide Size 0	2-0230700	1
2	Notch reamer Size 0	2-0231300	1
3	Femoral resection guide size 0	2-0203600	1
4	ANATOMIC Trial femoral component posterior stabilized left Size 0	2-0231200	1
5	ANATOMIC Trial femoral component posterior stabilized right Size 0	2-0231100	1
6	ANATOMIC Trial baseplate posterior stabilized Size 0	2-0231000	1
7	ANATOMIC Trial fixed bearing insert, PS – Size 0, Height 10	2-0230601	1
8	ANATOMIC Trial fixed bearing insert, PS – Size 0, Height 12	2-0230602	1
9	ANATOMIC Trial fixed bearing insert, PS – Size 0, Height 14	2-0230603	1
10	ANATOMIC Trial fixed bearing insert, PS – Size 0, Height 16	2-0230604	1
11	ANATOMIC Trial fixed bearing insert, PS – Size 0, Height 18	2-0230605	1
12	ANATOMIC Trial fixed bearing insert, PS – Size 0, Height 20	2-0230606	1
13	Femoral preparation guide Size 8	2-0230708	1
14	Notch reamer Size 8	2-0231308	1
15	Femoral resection guide size 8	2-0203608	1
16	ANATOMIC Trial femoral component posterior stabilized right Size 8	2-0231108	1
17	ANATOMIC Trial femoral component posterior stabilized left Size 8	2-0231208	1
18	ANATOMIC Trial baseplate posterior stabilized Size 8	2-0231008	1
19	ANATOMIC Trial fixed bearing insert, PS – Size 8, Height 10	2-0230680	1
20	ANATOMIC Trial fixed bearing insert, PS – Size 8, Height 12	2-0230681	1
21	ANATOMIC Trial fixed bearing insert, PS – Size 8, Height 14	2-0230682	1
22	ANATOMIC Trial fixed bearing insert, PS – Size 8, Height 16	2-0230683	1
23	ANATOMIC Trial fixed bearing insert, PS – Size 8, Height 18	2-0230684	1
24	ANATOMIC Trial fixed bearing insert, PS – Size 8, Height 20	2-0230685	1

Instrumentation

SCORE TKA MIS Cutting guides

2-0299945

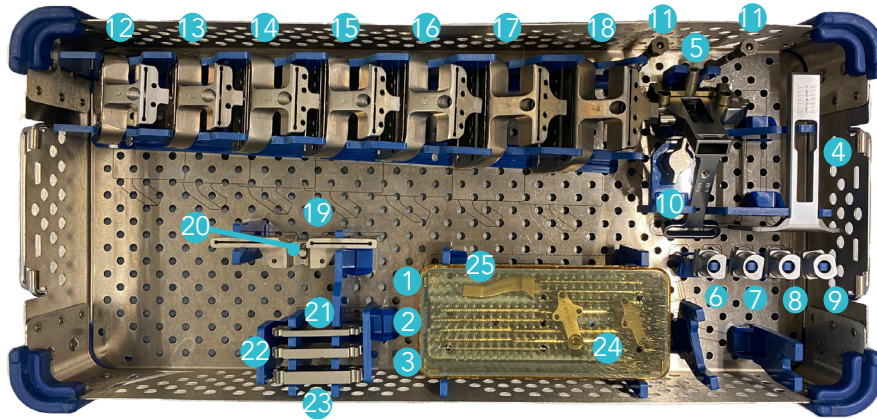

Item	Name	Product No.	Qty
1	Threaded pin \varnothing 4 length 90 mm	2-0200901	5
2	Smooth Pin \varnothing 4 Length 90 mm	2-0201000	2
3	Headed pin length 70 mm	2-0201302	4
4	Posterior plate for sizing guide	2-0203100	1
5	Sizing Guide	2-0203200	1
6	Valgus Alignment Guide 3°	2-0203303	1
7	Valgus Alignment Guide 5°	2-0203305	1
8	Valgus Alignment Guide 7°	2-0203307	1
9	Valgus Alignment Guide 9°	2-0203309	1
10	Anterior femoral stylus	2-0203400	1
11	Drill guide for pin \varnothing 4	2-0203500	2
12	IMA femoral resection guide size 1	2-0217701	1
13	IMA femoral resection guide size 2	2-0217702	1
14	IMA femoral resection guide size 3	2-0217703	1
15	IMA femoral resection guide size 4	2-0217704	1
16	IMA femoral resection guide size 5	2-0217705	1
17	IMA femoral resection guide size 6	2-0217706	1
18	IMA femoral resection guide size 7	2-0217707	1
19	Additional distal resection guide	2-0203700	1
20	Wheel for resection guide	2-0203800	1
21	Femoral recutting wedge - 4 mm	2-0206004	1
22	Femoral recutting wedge - 6 mm	2-0206006	1
23	Femoral recutting wedge - 8 mm	2-0206008	1
24	Bracket for MIS 5 in 1 revision femoral resection guide	2-0217900	2
25	Femoral resection guide stabilizer	2-0217800	1



Instrumentation

Gap balancing simulation

2-0299904

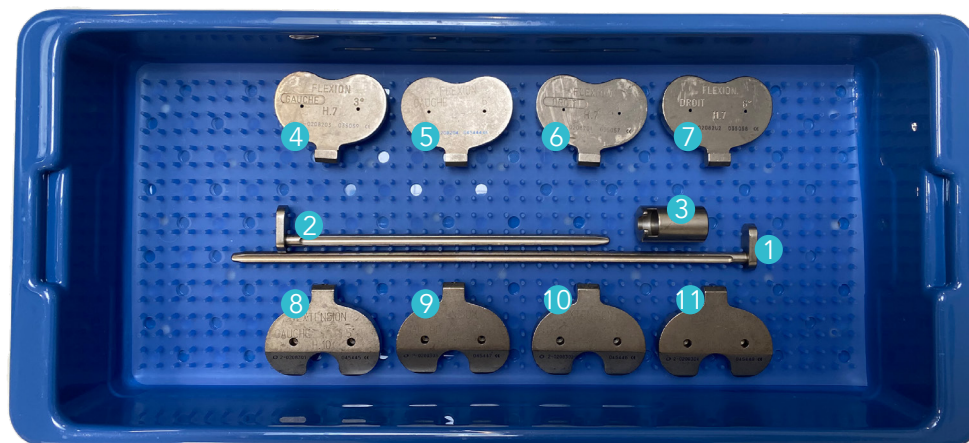

Item	Name	Product No.	Qty
1	Intramedullary balancing simulator rod	2-0208000	1
2	Short intramedullary balancing simulator stem	2-0209400	1
3	Impactor-extractor tip for intramedullary balancing simulator stem	2-0208100	1
4	Flexion spacer - Right - angle 3° Height 7 mm	2-0208201	1
5	Flexion spacer - Right - angle 6° Height 7 mm	2-0208202	1
6	Flexion spacer - Left - angle 3° Height 7 mm	2-0208203	1
7	Flexion spacer - Left - angle 6° Height 7 mm	2-0208204	1
8	Extension spacer - Left - angle 5° Height 10 mm	2-0208301	1
9	Extension spacer - Right - angle 5° Height 10 mm	2-0208302	1
10	Extension spacer - Left - angle 7° Height 10 mm	2-0208303	1
11	Extension spacer - Right - angle 7° Height 10 mm	2-0208304	1

Instrumentation

Large saw blades

SYNTHES AO / SODEM large Sawblade

Sterile Product No. 2-0227901

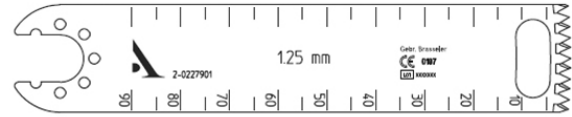

STRYKER large Sawblade

Sterile Product No. 2-0227902

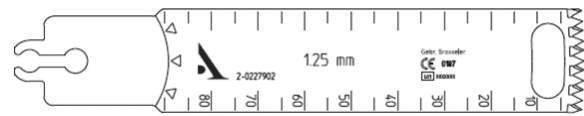

ZIMMER / HALL / LINVATEC large Sawblade

Sterile Product No. 2-0227903

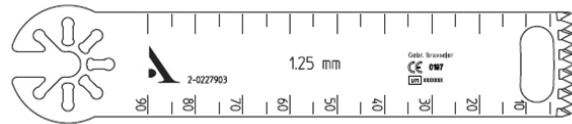

Medium saw blades

SYNTHES AO / SODEM medium Sawblade

Sterile Product No. 2-0228001



STRYKER medium Sawblade

Sterile Product No. 2-0228002

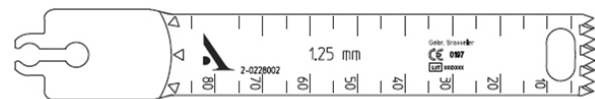

ZIMMER / HALL / LINVATEC medium Sawblade

Sterile Product No. 2-0228003





Customer Service – France :

Porte du Grand Lyon,
01700 Neyron – France
Tél. : **+33 (0)4 37 85 19 19**
Fax : +33 (0)4 37 85 19 18
E-mail : amplitude@amplitude-ortho.com

Customer Service – Export :

11, cours Jacques Offenbach, ZA Mozart 2,
26000 Valence – France
Tél. : **+33 (0)4 75 41 87 41**
Fax : +33 (0)4 75 41 87 42

www.amplitude-ortho.com

Reference : TO.G.001/EN/C