

score
score AS

amplitude



Surgical technique

Primary Total Knee System

Mobile bearing

Cemented or cementless

Conventional Instrumentation 5-in-1

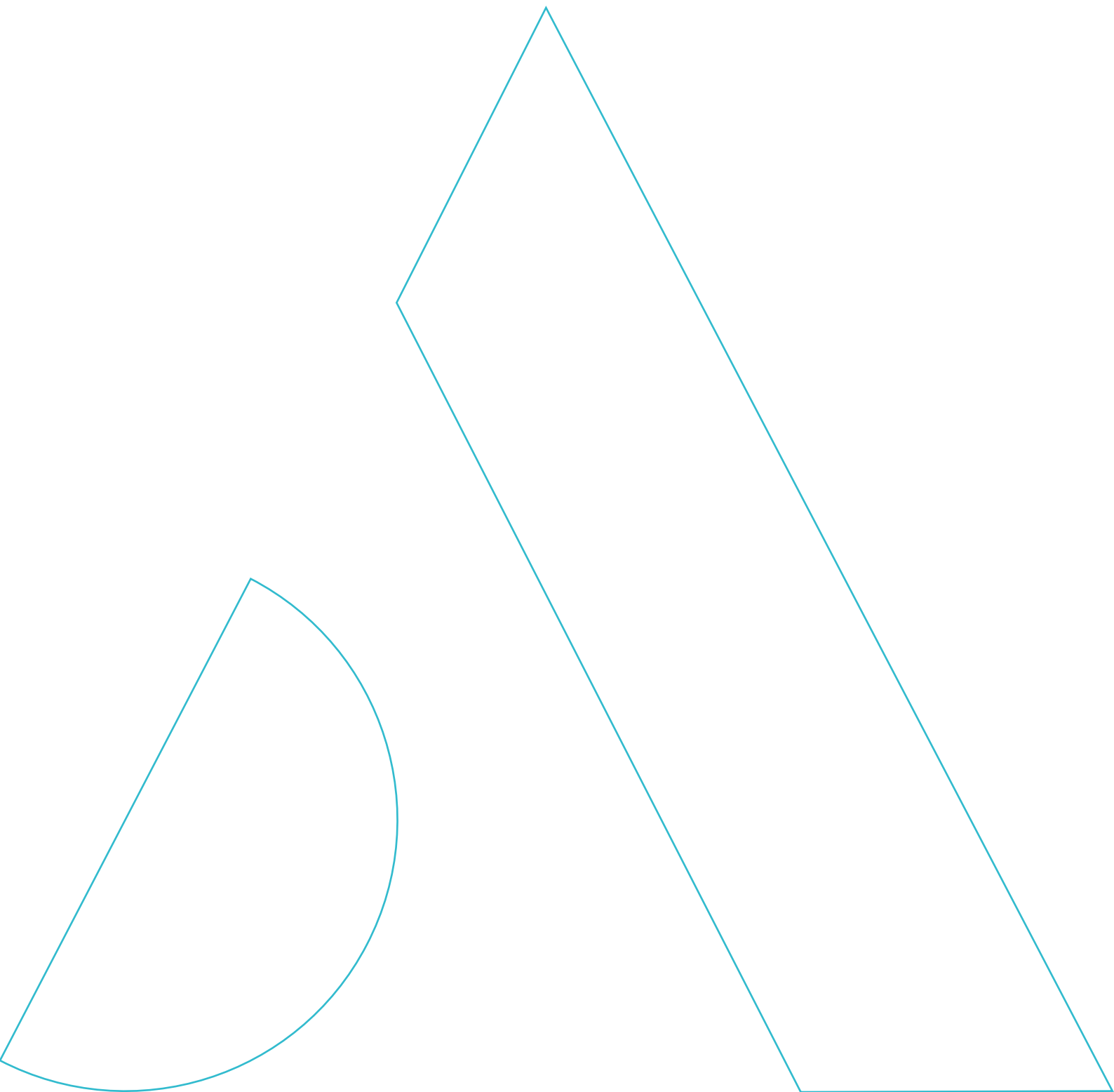

Table of contents

Introduction	4
Overview of the implant	5
Overview of the surgical technique	11
Step 1 - Pre-operative planning	14
Step 2 - Intra-medullary guide	15
Step 3 - Extra-medullary guide	16
Step 4 - Combined tibial guide	17
Step 5 - Tibial resection	18
Step 6 - Extension and flexion gaps	19
Step 7 - Femoral positioning	20
Step 8 - Femoral resections	25
Step 9 - Extension and flexion gaps	26
Step 10 - Distal femoral recutting	27
Step 11 - Changing sizes	27
Step 12 - Femoral preparation	28
Step 13 - Tibial preparation	29
Step 14 - Patella preparation: patellar resection option	30
Step 15 - Patella preparation: patellar reaming option	31
Step 16 - Definitive implants	32
Option: Simulated gap balancing before femoral cuts	33
Option: Distal femoral pre-cut	34
Option: MIS femoral resection guides	35
Option: Tibial augment, tibial extension stem and offset adapter	36
Instrumentation	41

Introduction

- This surgical technique is related to the SCORE instrument set and the 5-in-1 femoral cutting instrument set which allow the SCORE Total Knee Prosthesis to be fitted.
- The instrumentation can be used:
 - in conventional (mechanical) version
 - in Computer-Assisted Surgery version (by adding the AMPLIVISION Navigation Set)
 - with the i.M.A.G.E. Patient Specific Instrumentation (by adding the i.M.A.G.E. 5-in-1 for TKA set).

Not all devices presented in this Surgical Technique may be registered in your country. Please contact your Amplitude Sales Representative for availability.



Overview of the implant

- ▶ The SCORE / SCORE Allergy Solution (AS) TKS is a PCL-sacrificing and mobile bearing implant for primary knee arthroplasty.
- ▶ The stability is provided by sagittal and frontal congruency through the extension to the flexion.
- ▶ The SCORE TKS is available in cemented or cementless versions .
- ▶ The SCORE AS TKS is coated with Titanium Nitride (TiN) ceramic to minimise allergic reactions. It is only available in cemented version.



Femoral component

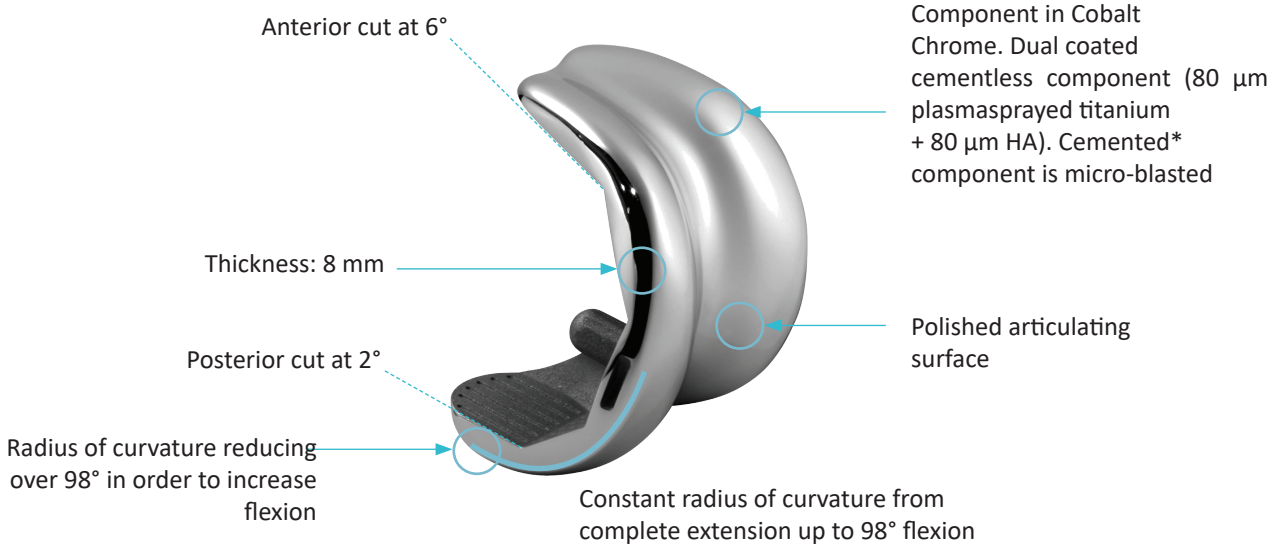

*Cobalt Chrome SCORE AS femoral component coated with Titanium Nitride (TiN)
Cemented version only.

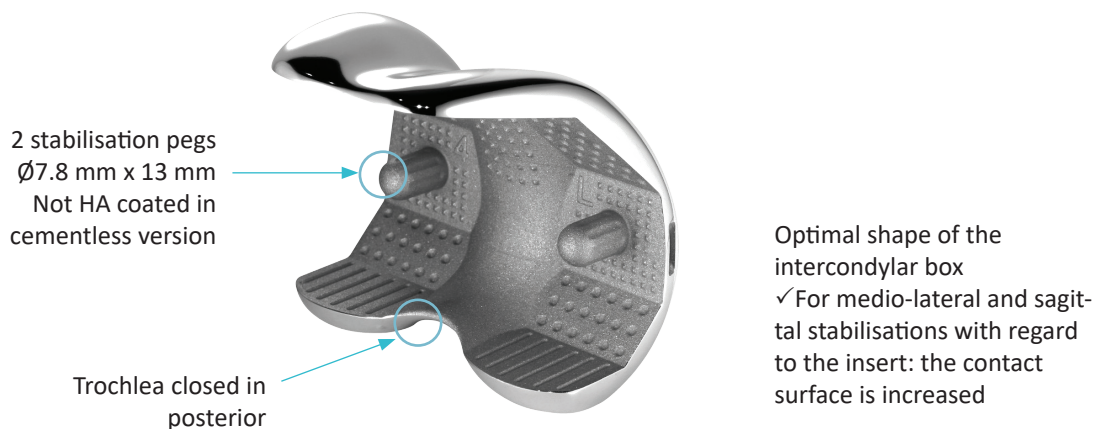

Patella component

Polyethylene patellar implant available in three versions:

Onset patellar implant cemented

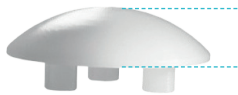

Thickness:
8 mm

Inset patellar implant cemented



Thickness:
7 mm

Tibial component

Tibial insert is mobile in rotation:

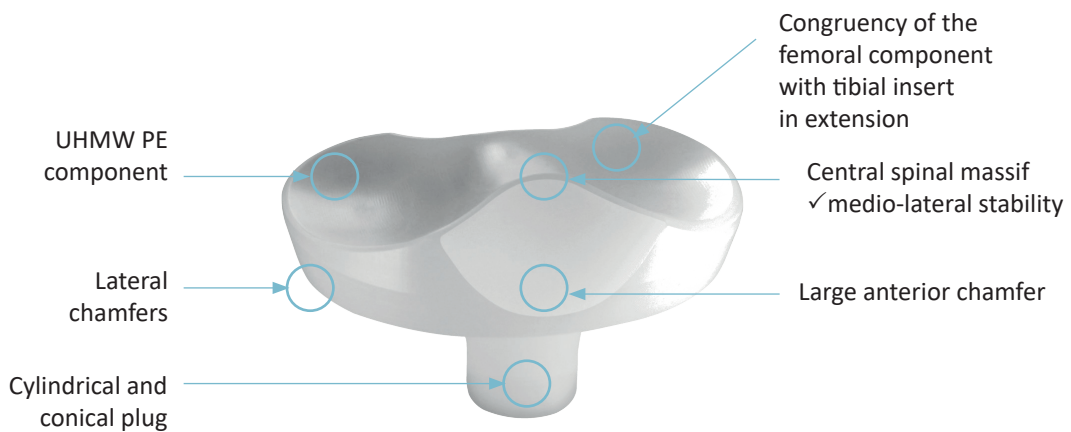

Tibial component

Tibial baseplate

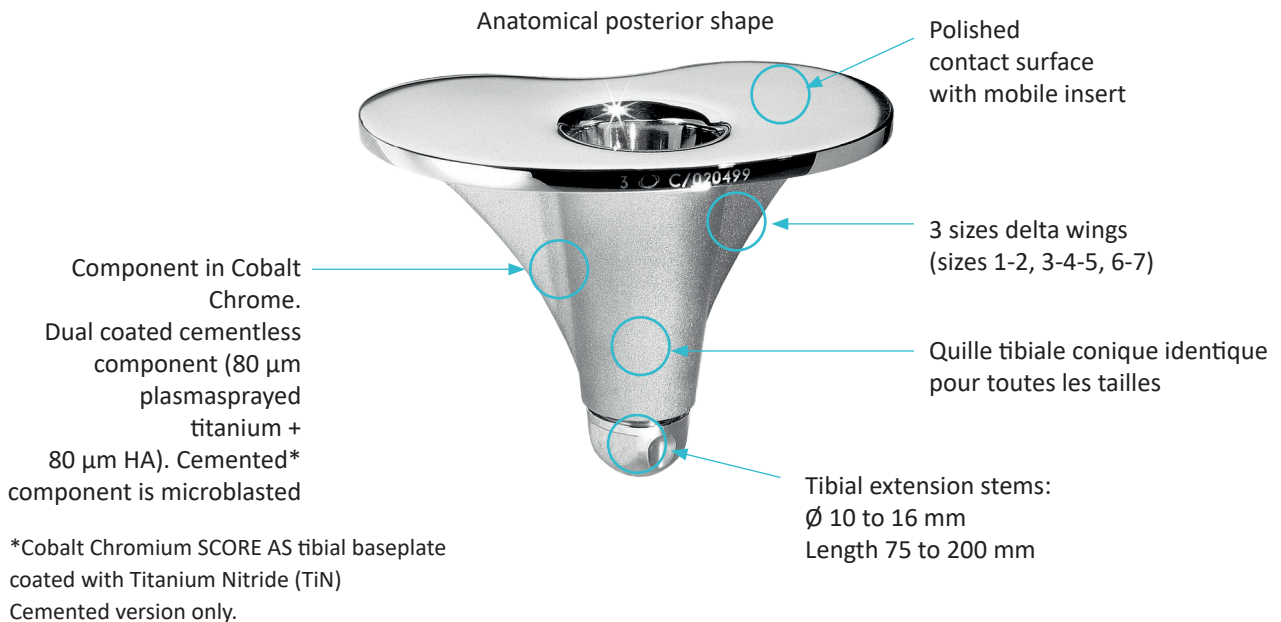

Possibility of using (e.g. in cases of uni revision, or TKA):

	SCORE	SCORE AS	
<p>- Tibial extension stems:</p> <ul style="list-style-type: none"> - Ø 10 to 16 mm - Length 75 to 200 mm 			<p>- Tibial extension stems:</p> <ul style="list-style-type: none"> - Ø10 Lengths 75mm and 100mm - Ø12 Longueur 75 mm
<p>- Tibial augments:</p> <ul style="list-style-type: none"> - Thickness 5 mm - Thickness 10 mm - Thickness 15 mm 			<p>- Tibial augments:</p> <ul style="list-style-type: none"> - Thickness 5 mm
<p>- Offset adapters:</p> <ul style="list-style-type: none"> - 2 mm - 4 mm - 6 mm 			

*The tibial extension stems, the tibial augments, and the offset adapters are intended to be implanted with orthopaedic cement only. SCORE accessories are compatible with the Cemented SCORE baseplate. The AS accessories are compatible with the SCORE AS baseplate.

Range

Femoral components:

- Cemented: 7 sizes
- Cementless (only for SCORE): 7 sizes



Δ AP: increment between sizes: 2.66 mm

Δ ML: increment between sizes: 3.3 mm

	1	2	3	4	5	6	7
AP	47.1	49.7	52.3	54.9	57.5	60.1	62.6
ML	60	63.3	66.7	70	73.3	76.7	80

Tibial components:

- Resurfacing patellar implant - cemented: \varnothing 30, 33, 36 and 39 mm
- Inset patellar implant - cemented: \varnothing 23, 26 and 29 mm

Tibial components:

- Cemented: 7 sizes
- Cementless (only for SCORE): 7 sizes

Δ AP: 2,3 mm

Δ ML: 3,5 mm



	1	2	3	4	5	6	7
AP	41,4	43,6	45,9	48,2	50,5	52,8	55
ML	63,5	67	70,5	74	77,5	81	84,5

- Inserts: 7 sizes

5 thicknesses (10, 12, 14, 16 and 20 mm)

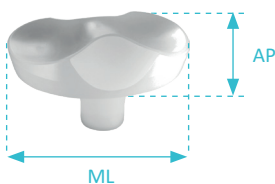

Δ AP: 2,1 mm

Δ ML: 3,3 mm



Component compatibility

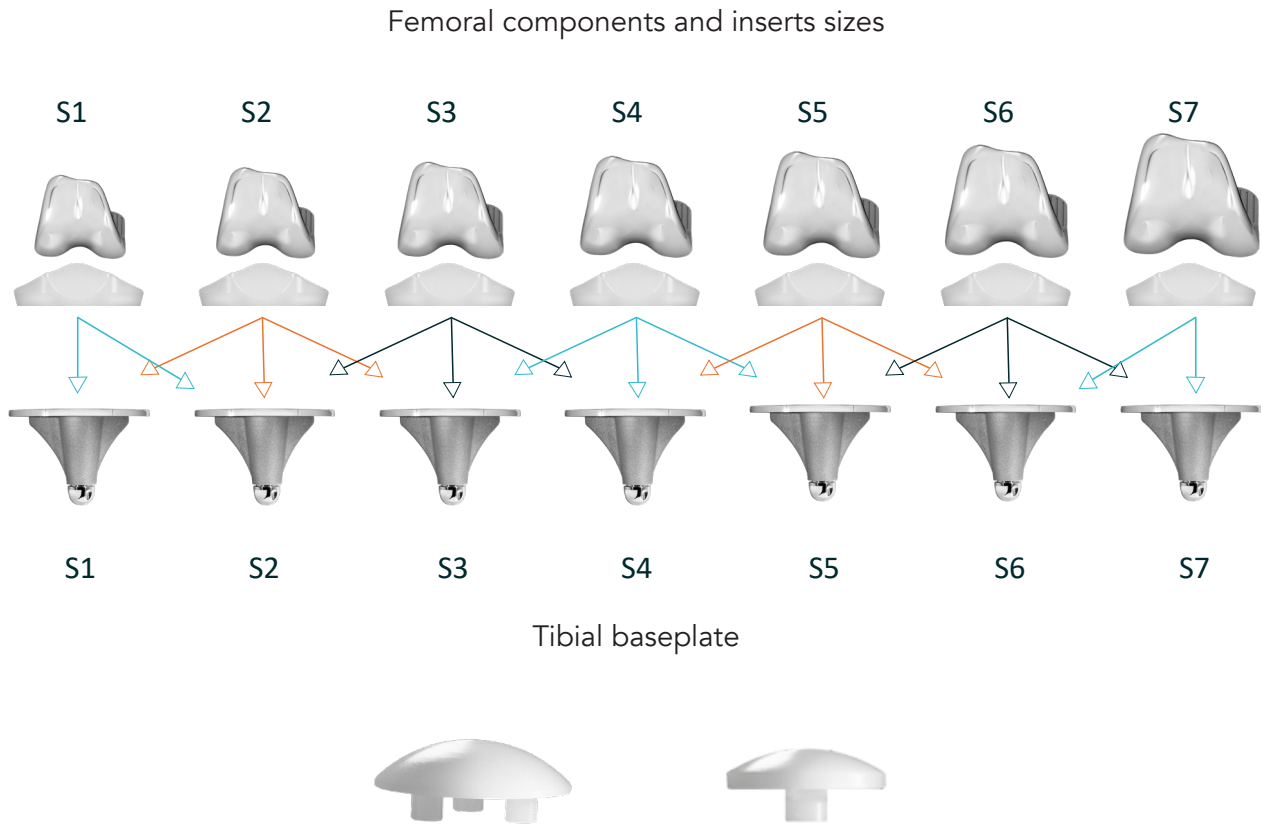

All sizes of Cemented resurfacing patellar implants and Cemented inset patellar implant are compatible with all sizes of SCORE femoral components.

Overview of the surgical technique

1

Intramedullary tibial aiming



2

Extramedullary tibial aiming



3

Tibial cut

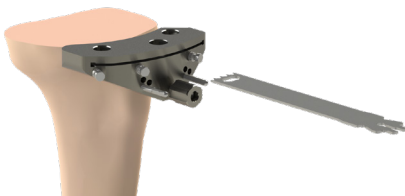

4

Femoral size selection

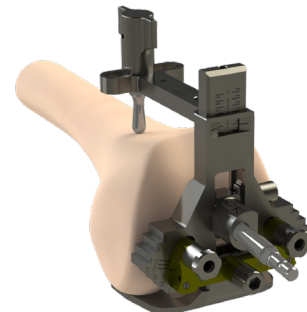

Overview of the surgical technique

5

Anterior reference selection

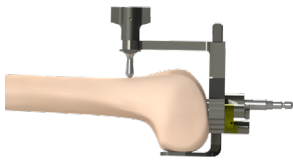

Posterior reference selection

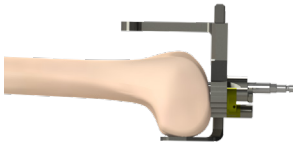

6

Rotation selection

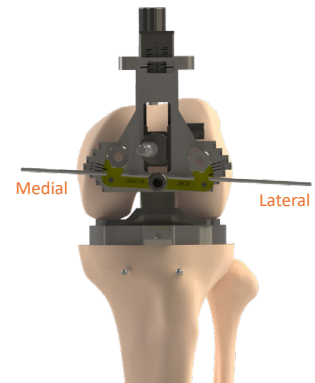

7

Setting up smoothed pins

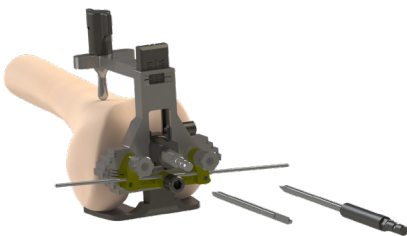

8

Femoral cuts

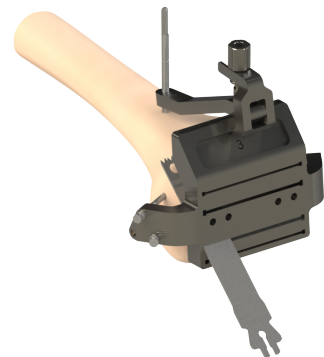

Overview of the surgical technique

9

Trochlear groove preparation

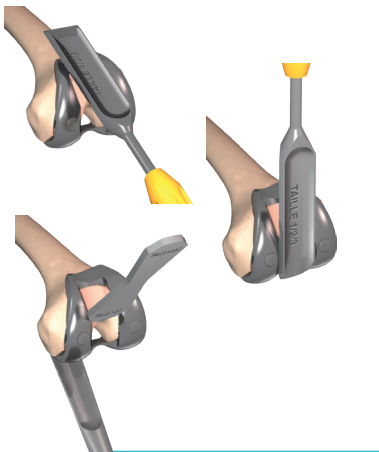

10

Tibial plateau preparation

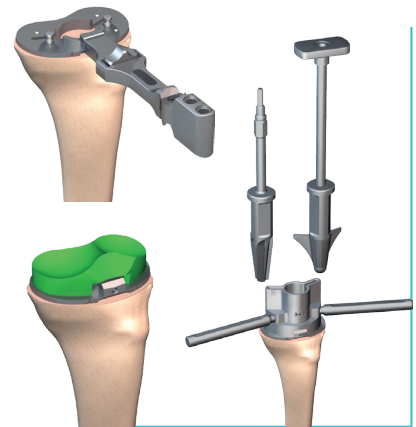

11

Patellar preparation
Resurfacing option



12

Patellar preparation
Patellar reaming option



1 Pre-operative planning

Using X rays and templates, you can determine concerning bone:

On the tibia:

- The choice between intramedullary and extramedullary aiming.
- The entry point of the intramedullary rod (coronal and sagittal view).
- The adaptation of the tibial stem to the metaphysis (in case of previous tibial osteotomy).
- The osteophytes.
- The severity of the compartment wear.
- The choice of an extension tibial stem, if required.
- The assessment of the baseplate size and the insert thickness.

On the femur:

- The entry point of the intramedullary rod (front and sideways).
- The anatomical femoral valgus angle.
- The posterior osteophytes.
- The size.

On the patella:

- The wear of the patellofemoral joint.
- The thickness, the width, the global shape, the tilt and the height of the patella.
- The thickness and the orientation of the patellar resection.
- The mediolateral position of the patellar implant.

NOTE

The provided templates have a 1:1 scale. Make sure the template scale matches the X-ray scale.

REMINDER

This surgical technique describes how to use the instrumentation properly. The surgeon is fully responsible for choosing the surgical approach and technique.

2 Intra-medullary guide



Intramedullary tibial alignment:

- Based on the pre-operative planning, determine the entry point for the intramedullary (IM) canal and open the tibial canal with the Intra-medullary Drill Bit.
- Assemble the Intra-medullary Rod - Length 400 mm on the T Wrench and insert it into the canal, the landmark must always be visible.

NOTE

If the intra-medullary Rod- Length 400 mm cannot be inserted use the Intra-medullary Rod Length 250 mm.

Assembly of the Intramedullary System:

- Attach the tibial slide bar and the tibial resection guide (left or right) together onto the tibial bracket. Tighten the Wheel for resection guide and the Wheel for tibial bracket with the H5 Screwdriver or by hand.
- Insert this entire unit onto the intramedullary rod, adjust its rotation relative to the anterior tibial tuberosity and then impact the tabs.
- Clip the tibial stylus onto the resection guide (make sure the clip is fully engaged).
- Set the resection height by using the tibial stylus to palpate either the:
 - healthy side (10 mm cut relative to the chosen point),
 - worn side (0 mm cut relative to the chosen point (exit level of the saw blade)).
- For other resection heights, use the 2 mm markings on the tibial slide bar.
- Verify the height of the bone cut with the resection gauge.



NOTE

You can check the axis using the Alignment gauge assembled with the Universal handle in which the Extramedullary alignment rod slides.



3

Extra-medullary guide (EM)



△ Assembly of the Extramedullary System and resection height adjustment:

- Attach the tibial slide bar and the tibial resection guide (left or right) together onto the tibial bracket. Tighten the Wheel for resection guide and the Wheel for tibial bracket with the H5 Screwdriver or by hand.
- Assemble the malleolar clamp with the extramedullary alignment guide and with the tibial slide bar.
- Place the malleolar clamp around the ankle, and then place the tibial bracket on the intercondylar eminence.
- Tighten the Wheel for extramedullary Alignment column.
- Set the rotational and sagittal alignments before impacting the tabs.
- Clip the tibial stylus onto the tibial resection guide (make sure the clip is fully engaged).
- Set the resection height by using the stylus to palpate either the:
 - healthy side (10 mm cut relative to the chosen point),
 - worn side (0 mm cut relative to the chosen point (exit level of the saw blade)).
- For other resection heights, use the 2 mm markings on the tibial slide bar.
- Verify the height of the bone cut with the resection gauge.

NOTE

You can check the axis using the Alignment gauge assembled with the Universal handle in which the Extramedullary alignment rod slides.

4 Combined tibial guide



Landmarks:

- See page 15

Assembly of the Combined System and resection height adjustment:

- Attach the tibial slide bar and the tibial resection guide (left or right) together onto the bracket. Tighten the Wheel for tibial bracket.
- Assemble the malleolar clamp with the extramedullary alignment guide and with the tibial slide bar.
- Place the malleolar clamp around the ankle and then place the tibial bracket onto the intercondylar eminence.
- Set the rotational and sagittal alignments before impacting the tabs.
- Clip the tibial stylus onto the resection guide (make sure the clip is fully engaged).
- Set the resection height by using the stylus to palpate either the:
 - healthy side (10 mm cut relative to the chosen point),
 - worn side (0 mm cut relative to the chosen point (exit level of the saw blade))
- For other resection heights, use the 2 mm markings on the tibial slide bar.
- Check the bone cut height with the resection gauge.

NOTE

You can check the axis using the Alignment gauge assembled with the Universal handle in which the Extramedullary alignment rod slides.

5 Tibial resection

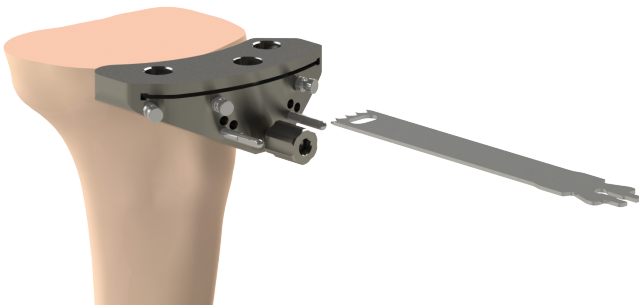

- Place 2 Headless pin length 80 mm in the 0 mm holes (with the Universal quick release adaptor for pin or Pin Driver AO).
- The +2 and +4 markers will be used if a tibial recut is required.
- Place the « T » end of the slaphammer into the opening on the tibial bracket and then remove the entire intra- or extramedullary assembly.
- Place the resection guide flush with the anterior tibial cortex.
- Insert 3 Headed pin length 70 mm (or the Collared Threaded Pins $\varnothing 3.2$ -L57), to stabilize the resection guide.

NOTE

Depending on the bone quality, a Long Drill bit, $\varnothing 3.2$, length 145 mm can be used to make the holes for the pins.

- Perform the tibial cut.
- Remove the headed pins with the pins extractor.
- Slide the resection guide off the pins, by leaving the pins in place in case a recut was necessary (the +2 and +4 holes will be used at that time).
- The flat rasp can be used to flatten the tibial resection.

6 Extension and flexion gaps

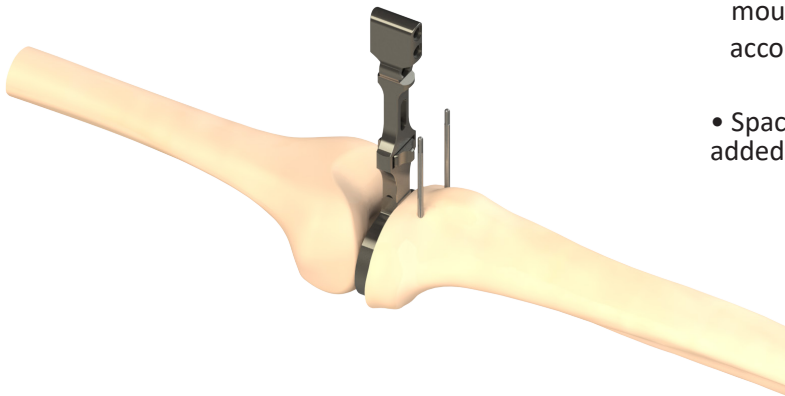

- It is then possible to check gaps using a 10 mm spacer mounted on the universal handle which may accommodate extramedullary alignment rods.
- Spacer thickness 2 mm and 4 mm for spacer may also added to the 10 mm spacer to improve ligament tension.

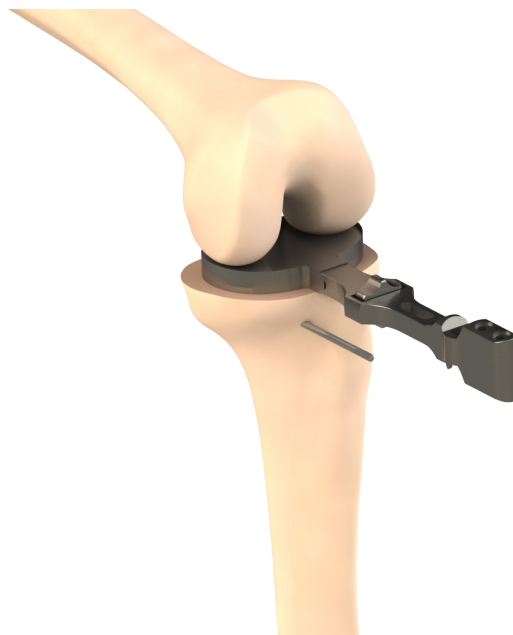

7 Femoral positioning

▷ Intramedullary femoral aiming:

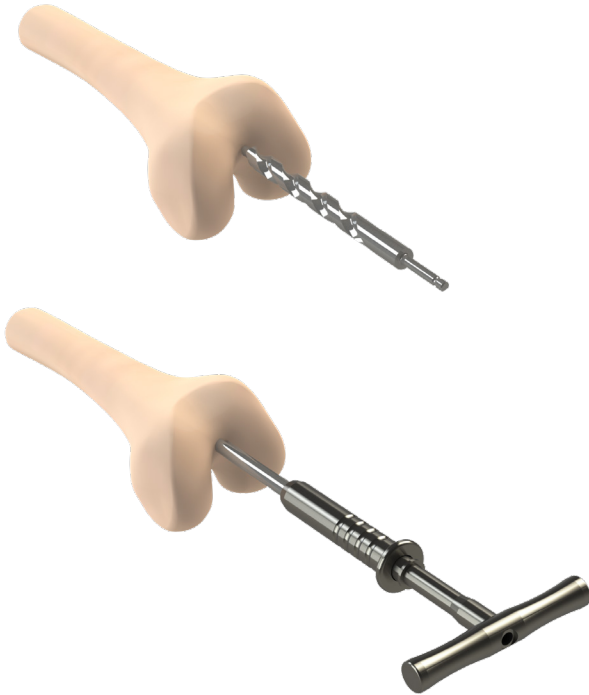

- Bend the knee at 90°.
- Remove any peripheral osteophytes.
- Clear out tissues to access the anterior cortex.
- Based on the pre-operative planning, determine the entry point for the intramedullary canal and open the femoral canal with the Intramedullary Drill Bit.
- Assemble the Intramedullary Rod - Length 400 mm on the T Wrench, and insert it into the canal. The landmark located on the Rod must always be visible.

NOTE

If the intra-medullary Rod– Length 400 mm cannot be inserted use the Intra-medullary Rod-Length 250 mm.

7 Femoral positioning

▷ Femoral A/P measurement:

- Position the Sizing Guide with the Valgus Alignment Guide 5° (or 3°, 7°, 9°) corresponding to the operated side, on the Intramedullary Rod.
- Ensure it is in contact with at least one of the distal condyles.
- Make sure the Posterior plate for sizing guide rests on the two posterior condyles.
- Place the Anterior Femoral Stylus on the anterior cortex, and move it side to side as needed.
- Use the H5 screwdriver to tighten the side screw and set the anteroposterior size.
- Place the Spacer Thickness 7 mm between the paddles of the Posterior Plate for Sizing (3 mm thick) and the tibial cut to simulate a 10 mm thick tibial cut.
- The Spacer thickness 2 mm (or 4mm) for spacer may be added to the 7 mm spacer to further refine the ligament tension.
- Evaluate the laxity with the knee flexed.

NOTE
Push and turn the stylus simultaneously to assemble it.

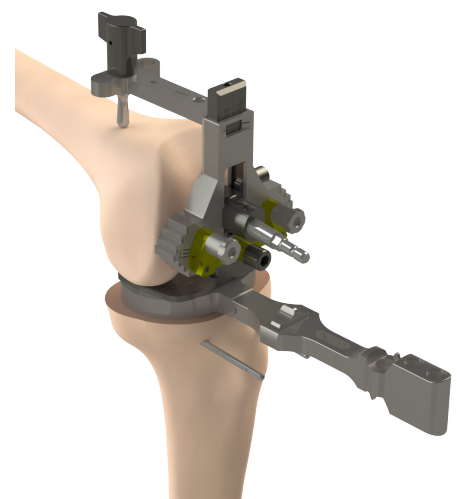
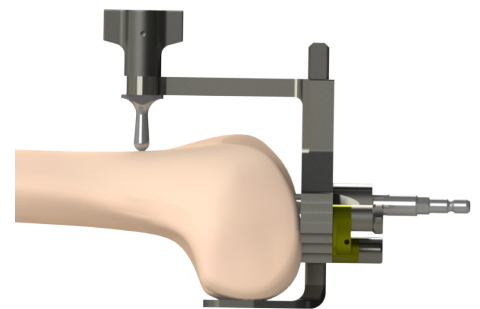

NOTE
For patients with a non-reducible flexion deformity, a distal femoral precut can be made (see page 33).

7 Femoral positioning

◊ Femoral component size selection:

- Read the size from the markings.

Two scenarios may occur:

1: You can read an exact size:

- The anterior and posterior reference points will be used simultaneously. The thickness of the bone cut will be equal to the thickness of the implant: 8 mm posteriorly.
- Tighten the lateral screw with the screwdriver.

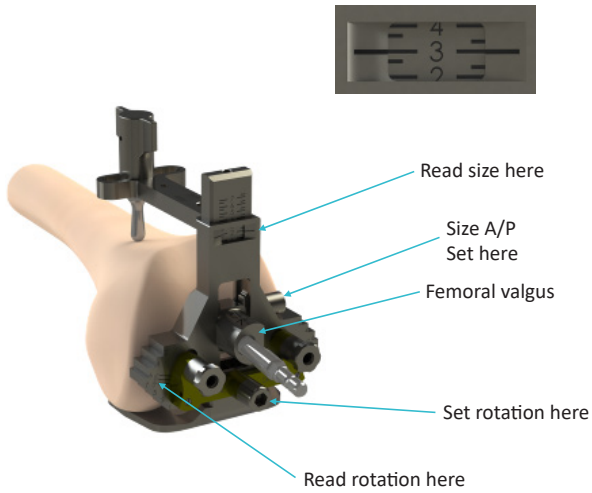

Example of reading between two sizes

2: The reading is between two sizes:

- The next larger or smaller can be used with either the anterior or the posterior reference point. This is possible because of the 2.6 mm increment between sizes and the 6° anterior cut.

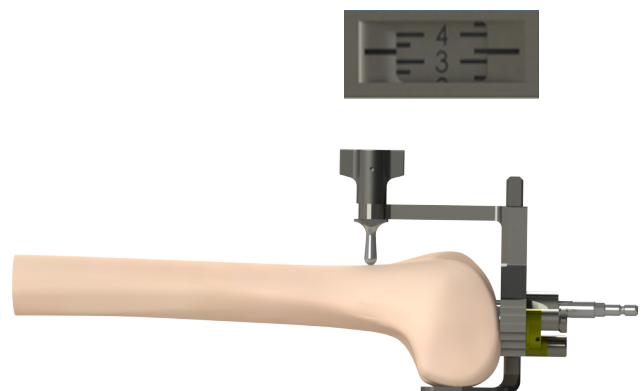

7 Femoral positioning

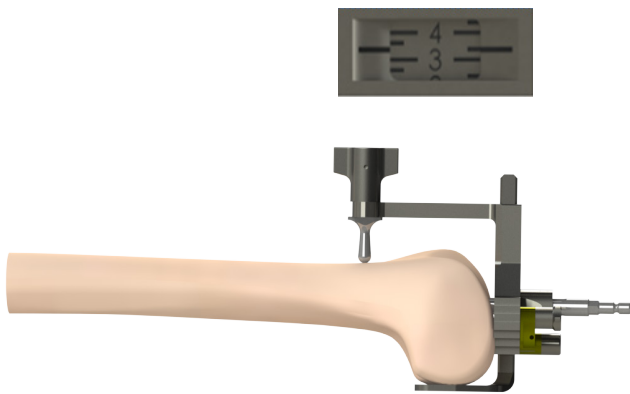

Example of reading between two sizes

∅ For an anterior reference point:

- The Posterior plate for sizing guide must stay in contact with the posterior condyles.
- The femoral stylus must touch the anterior cortex.
- The measured gap (millimetres) is then factored into the posterior condyle cut.
- For example, in the scenario shown on the previous page, where the reading corresponds to **Size 3 + 1 mm or Size 4 – 2 mm**:
 - **Smaller size selected** = 9 mm posterior cut (for an 8 mm implant thickness)
Increases gap in flexion.
 - **Larger size selected** = 6 mm posterior cut (for an 8 mm implant thickness)
Increases gap in flexion.

∅ For a posterior reference point:

- Remove the femoral stylus, but leave the Posterior plate for sizing guide against the posterior condyles.
- Place the laser marking on the chosen size.
- Fully tighten the side screw with the screwdriver.
- The measured gap (millimetres) is then factored into the anterior cut.

For example, in the scenario shown on the previous page, where the reading corresponds to **Size 3 + 1 mm or Size 4 – 2 mm**:

- **Smaller size selected** = 8 mm posterior cut (for an 8 mm implant thickness)
Anterior cut will be 1 mm lower due to the 6° anterior cut.
Flexion gap is maintained and loads on patella are reduced.
- **Larger size selected** = 8 mm posterior cut (for an 8 mm implant thickness)
Anterior cut will be 2 mm higher.
Flexion gap is maintained and loads on patella increase.

7 Femoral positioning

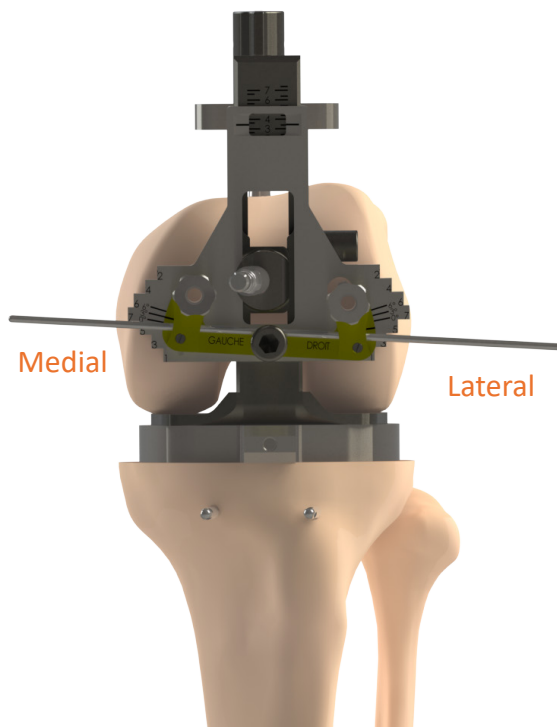

▷ Setting the rotation:

- The rotation can be determined using various anatomical and/or ligament-based landmarks.
- Anatomical landmarks:
 - Trans-epicondylar axis (TEA): insert 2 Alignment Pin $\varnothing 2$ Length 150 mm on each side of the Sizing Guide to visualize the alignment with the TEA.
 - Posterior condylar axis,
 - Anteroposterior axis.
- Ligament-based landmarks:
 - A gap balancing simulator is available upon request (see page 51).
- Once the rotation (0° , 3° or 6°) has been determined, place the Drill Guides for $\varnothing 4$ Pin in the Sizing Guide at the appropriate locations for the operated side.
- Fully tighten the front screw with the screwdriver.

8 Femoral resections

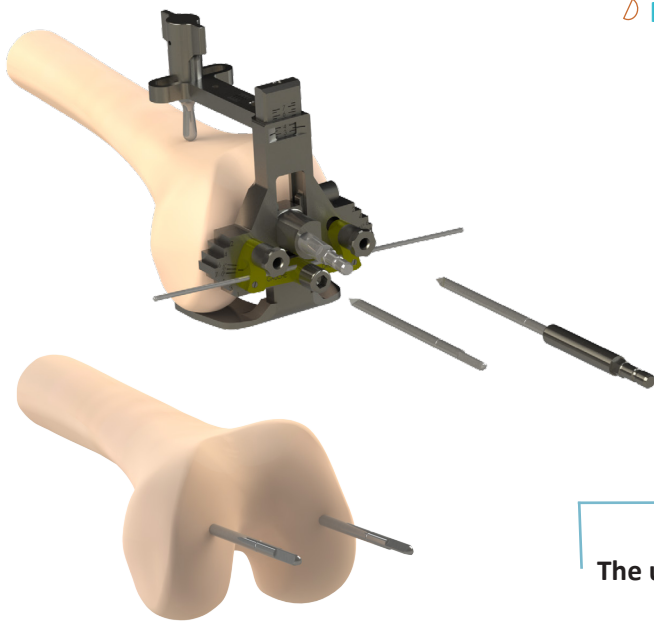

▷ Pins insertion:

- Use the power tool to drive two Smooth Pins Ø4, length 90 mm or Threaded Pins Ø4, length 90 mm into the Drill Guides for pin placed on the Sizing Guide until the landmark is reached.
- Use the Universal quick release adaptor for pin or Pin Driver AO to connect the pins to the handpiece.
- Remove the two Drill Guides, the intramedullary rod, and the Sizing Guide.

NOTE

The universal Adaptor and AO Pin Driver can also be used with the universal T wrench.

▷ Positioning of the 5-in-1 resection guide and cuts:

- Place the Femoral resection guide of the chosen size onto the pins.
- Make sure the guide touches at least one of the distal condyles.
- Position the Femoral Resection Guide Stabilizer and secure, tighten the Wheel for Resection Guide it with a Headed Pin Length 70mm.
- Starting with the side that is touching the distal condyle, secure the Femoral guide with four headed pins.
- Remove the two Pins Ø4, length 90 mm.
- Make the five cuts:
 - Anterior
 - Posterior
 - Anterior chamfer
 - Posterior chamfer
 - Distal
- Remove the headed pins with the pin extractor and then remove the resection guide.

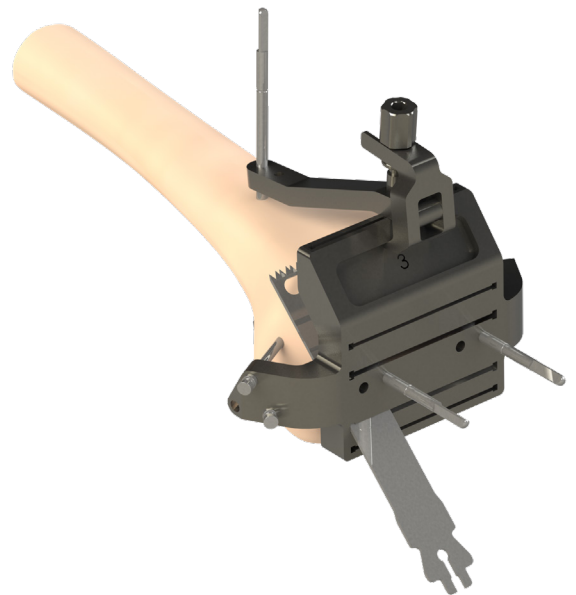

NOTE

Depending on the bone quality the Long Drill bit, Ø 3.2, length 145 mm can be used to make the holes for the pins.

NOTE

MIS 5-in-1 resection guides are available upon request (see page 50).

9 Extension and flexion gaps

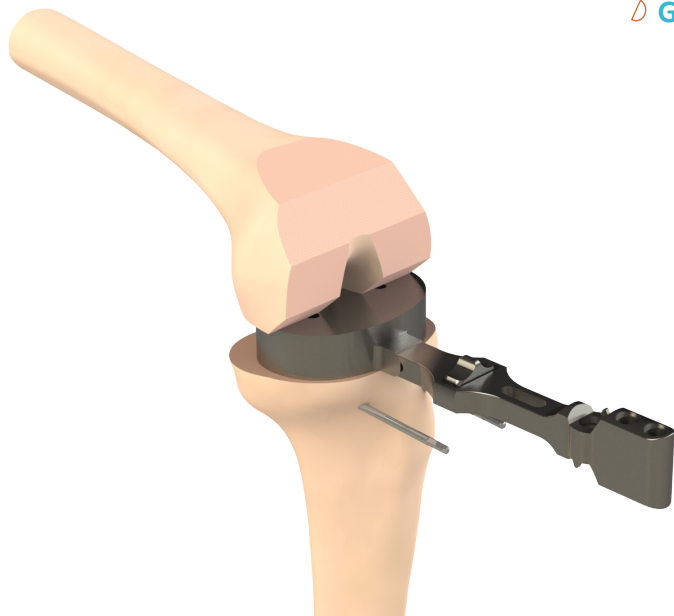

∪ Gaps evaluation:

- The flexion and extension gaps can be verified with the Spacer Thickness 18 mm (10 mm for the tibial cut + 8 mm for the femoral component).
- The Spacer thickness 2 mm for spacer (or 4 mm) may be added to the 18 mm spacer if necessary.

∪ Various scenarios may be encountered:

Observation	Solution
Knee has acceptable gaps in flexion and extension	Determine insert height
Knee is tight in flexion and extension	Perform the tibial cut again to remove an additional 2, or 4 mm of bone; use the pins that were left in the tibia (see page 18)
Knee is tight in extension, but acceptable in flexion	Repeat the femoral cuts using the 4 mm or 6 mm blocks (see below)
Knee has acceptable gaps in extension, but is tight in flexion	Select a smaller femoral component and redo the cuts using the 8 mm block (see below)

10 Distal femoral recutting

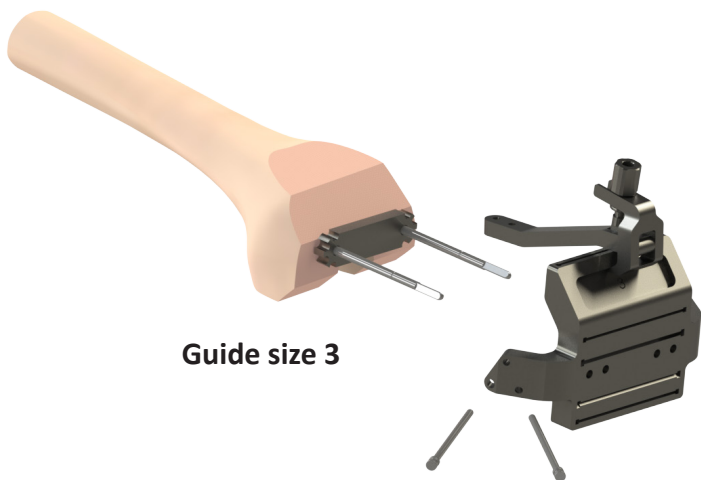

- Reintroduce the two Pins $\varnothing 4$, length 90 mm.
- Position the appropriate Femoral Recutting Wedge on these pins.
 - 6 mm: 2 mm re-cut
 - 4 mm: 4 mm re-cut
- Place the initial 5-in-1 Femoral Resection Guide flush against the Recutting Wedge.
- Add the Femoral Resection Guide Stabilizer.
- Secure it by placing two Pins $\varnothing 4$, length 90 mm in the most posterior holes on the guide and two Headed Pin length 70 mm in the most anterior holes (see drawing).
- Remove the two distal Pins $\varnothing 4$, length 90 mm and the Femoral Recutting Wedge.
- Perform the cuts.

11 Changing sizes

- Reintroduce the two Pins $\varnothing 4$, length 90 mm.
- Place the Femoral Recutting Wedge - 8 mm onto the two Pins $\varnothing 4$ mm.
- Place a smaller 5-in-1 Femoral Resection Guide flush against the block.
- Add the Femoral Resection Guide Stabilizer.
- Secure it by placing two Pins $\varnothing 4$, length 90 mm in the most posterior holes on the guide and two Headed Pin length 70 mm in the most anterior holes (see drawing).
- Remove the two distal Pins $\varnothing 4$, length 90 mm and the Femoral Recutting Wedge.
- Perform the cuts.

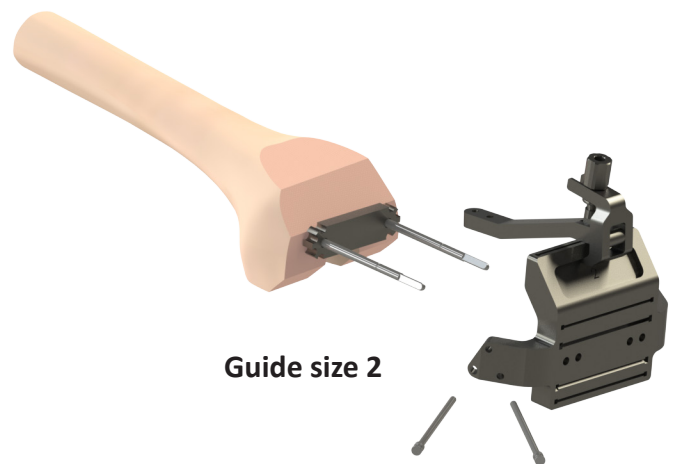

12 Femoral preparation

▷ Mediolateral femoral adjustment:

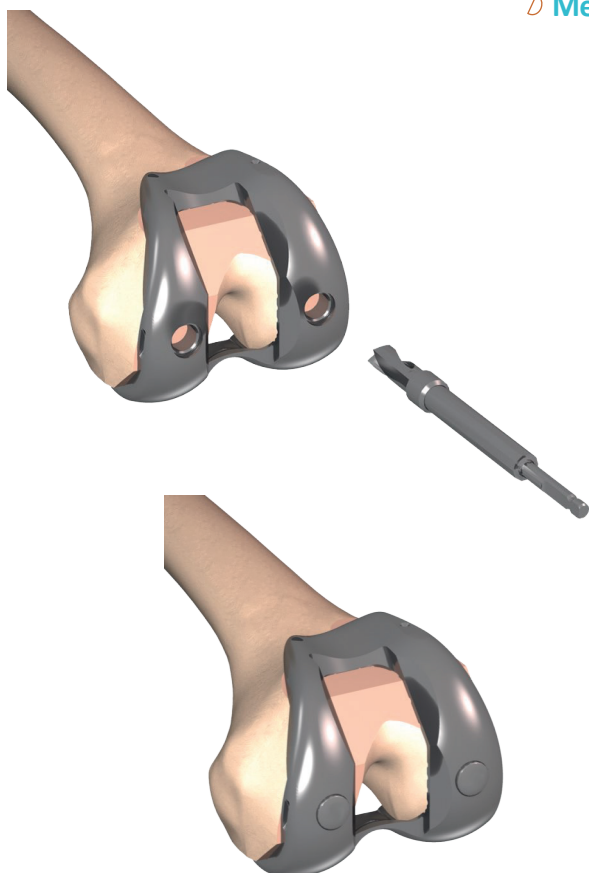

- Impact the SCORE Femoral Trial component (corresponding to the operated side and to the size of the Femoral Resection Guide) using the Femoral Condyle Holder (trial position), by choosing a mediolateral position.
- Finish impacting the Trial Component using the Femoral Component Impactor.
- Drill the first hole with the Drill for peg holes and insert the Trial peg for trial femoral component.
- Drill the second hole and insert the second Trial peg for trial femoral component.

▷ Trochlear groove preparation:

- Prepare the intercondylar notch using the cutting end of the Femoral Rasp that corresponds to the size of the selected femoral component (size 1/2/3 or size 4/5/6/7).
- The rasp is constrained on two sides. Finalise the preparation with the roughened end.
- Use the Intercondylar Control Gauge to ensure the intercondylar notch has been prepared correctly.
- Resect any posterior osteophytes with the Cutting Gauge.

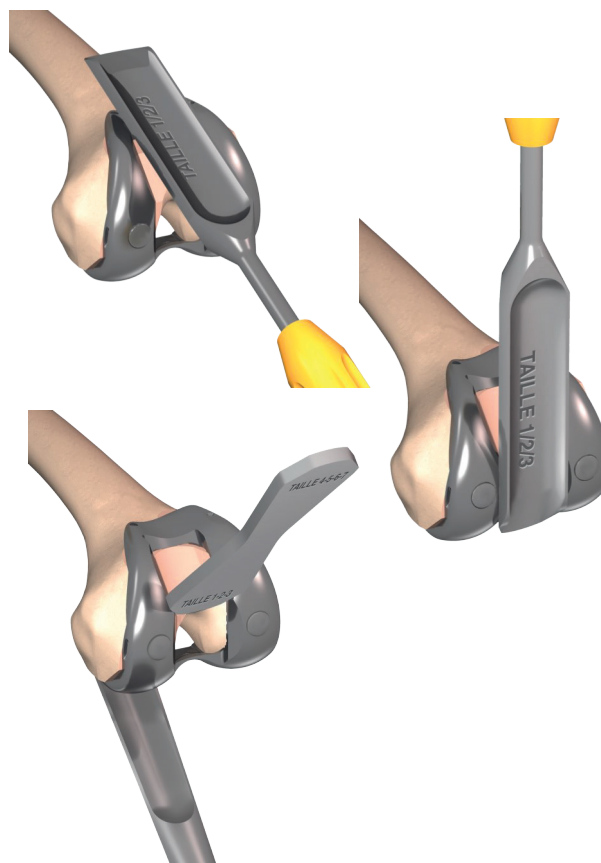

13 Tibial preparation

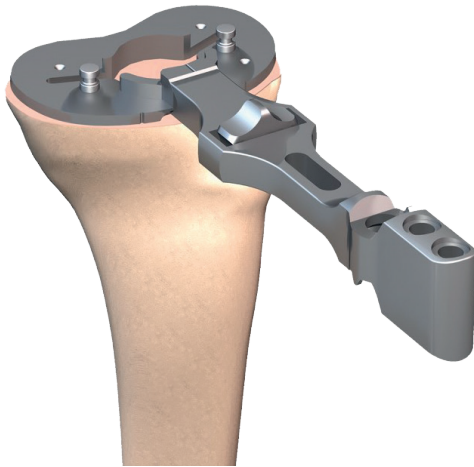

▷ Trial baseplate positioning:

- Determine the size of the Trial Tibial Baseplate. The baseplate can be one size larger or smaller than the size of the femoral component.
- Position the Trial Tibial Baseplate onto the tibial cut.
- Fix the baseplate with two Headed Pins length 30 mm.

NOTE

Depending on the bone quality a Long Drill bit, Ø 3.2, length 145 mm can be used to make the holes for the pins.

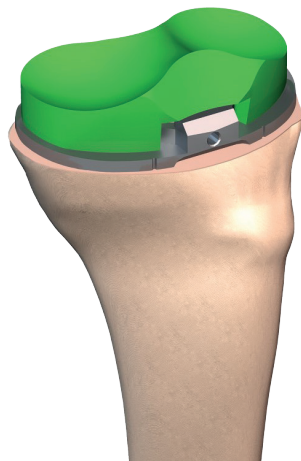

▷ Trials:

- Position the mobile Trial Insert of a size corresponding to the femur starting by Thickness 10mm.

NOTE

The insert size must always be identical to the femoral size.

▷ Preparation:

- Remove the 2 headless pins in the tibia.
- Tighten the Standard Trial Stem on the Punch Guide for Tibial Baseplate with the Tibial Stem Wrench.
- Position the appropriate size of the Punch guide for tibial baseplate (1/2 or 3/4/5 or 6/7) onto the Trial Tibial Baseplate. If needed Two Removable Handles for Punch Guide can be screwed on the Pun Guide to strongly maintain it.
- Ream using the Reamer for tibial extension stem until the stop (same for all sizes).
- Impact the appropriate sized Punch for Tibial Extension Stem (1/2 or 3/4/5 or 6/7), in case of a sclerotic bone or after osteotomy, prepare first with an osteotome.

NOTE

Check the integrity of the 2 instruments (Punch and Trial Stem) after extraction of the assembly.

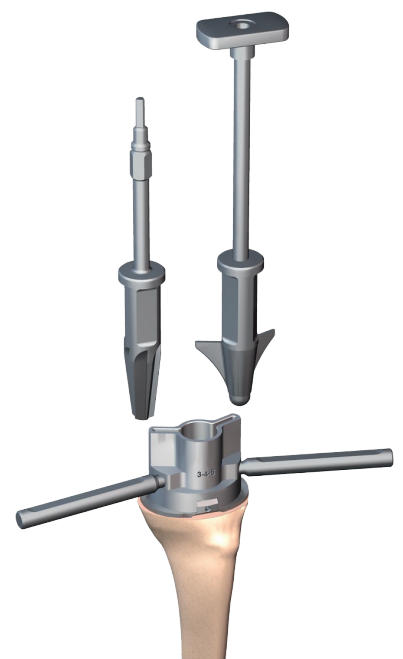

14 Patella preparation: patellar resection option



▷ Patellar preparation:

- Clear osteophytes.

▷ Position the patellar resection guide:

- Place the Patellar resection clamp so the two lugs are on the anterior side of the patella.
- With the clamp jaws open, bring the Patellar resection Gauge in contact with the articular surface using the adjustment knob.
- Lock the clamp.
- Evaluate remaining bone.
- Push the saw blade into the slot to perform the cut.

▷ Patellar preparation:

- Use the Patellar Drilling Guide $\varnothing 30$, $\varnothing 33$ or $\varnothing 36$ to determine the size of patellar component needed: 30, 33 or 36 mm
- Centre and impact the drilling guide.
- Make the 3 holes for the pegs with the Drill bit for resurfacing patella.
- Place the Trial resurfacing patella of the same diameter using the Clamp for Locking Ring.
- Test the articulation in the trochlea.

▷ Patellar implantation:

- Clean and dry the bone surface.
- Apply cement onto the implant and the patellar cut.
- Position the implant on the cut.
- Tighten the implant using the Patellar Impactation clamp.
- Remove the excess of cement.
- Keep the clamp until the cement is dry.

NOTE

The thickness of the patella implant is 8mm for all the diameters and it is advisable to leave a remnant of 12mm of residual bone.

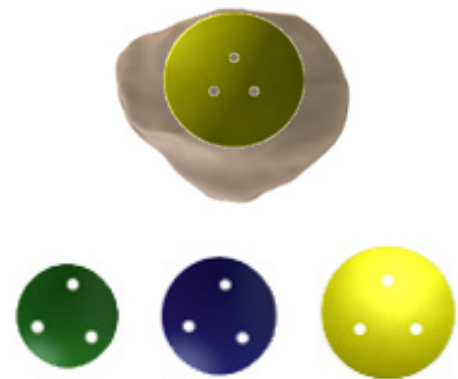

15 Patella preparation: Patellar reaming option



▷ Patellar preparation:

- Clear osteophytes.

▷ Position the Patellar reaming forceps:

- Centre the Trial inset patellar - cemented \varnothing 23 mm – Plastic (or \varnothing 26, or \varnothing 29) on the articular surface of the native patella.
- The appropriate size (\varnothing 23, 26 or 29 mm) is determined based on the following criteria:
 - Superior-to-inferior length of the articular surface
 - Width of the patella's medial articular facet
- The size must be slightly smaller (by about 2 mm) than the superior-to-inferior length of the articular surface and must be slightly inside the medial edge of the medial articular facet.
- Assemble the Patella Reamer Surfacing Guides corresponding to the chosen patellar implant size onto the Patellar reamer Clamp and lock it.
- Position the clamp. The inferior jaw on the Patellar reamer Clamp must rest against the anterior side of the patella. The clamp must rest against at least one of the patella's two articular facets.
- Use the thumb knob to tighten the Patellar reamer Clamp .
- Assemble the reamer for inset patella of the same size as the chosen clamp onto the power tool.
- Ream the patella until the stop is reached.

▷ Trials:

- Assemble the Patellar Reamer Impaction Clamp onto the Patellar reamer Clamp and lock it.
- Use it to place the Trial inset patellar - cemented of the selected size into the native patella.
- Test the patella tracking.

▷ Patellar implantation:

- Clean and dry the bone surface.
- Use the Patellar Reamer Impaction Clamp assemble on the Patellar reamer Clamp to insert the chosen patellar component.

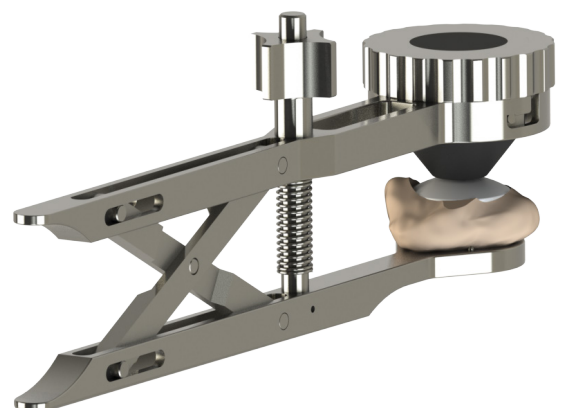

16 Definitive implants



▷ Insertion of chosen tibial baseplate:

- On the selected tibial baseplate (with or without cement), tighten the Standard stem using the Tibial Stem Wrench.
- Wash and dry bone surfaces and the joint space.
- For the cemented version, apply a layer of cement to the bone, the implant surface or to both.
- Position the tibial baseplate and impact it using the Baseplate impactor.
- For the cemented version, remove any excess cement taking care to limit the movement of the components while the cement is curing.

▷ Insertion of chosen insert:

- Place the polyethylene insert with the size corresponding to the femur and the thickness validated during testing.

▷ Insertion of chosen femoral component:

- Assemble the femoral implant (with or without cement) of the selected size on the Femoral condyle Holder (anterior position).
- If a cemented femoral implant is used, it is recommended to apply little cement on the posterior condyles and no cement on the posterior area of the notch, due to the implant design.
- Place the femoral component onto the femoral cuts, make sure it is aligned precisely, and then impact it so that the Femoral condyle holder can be removed.
- Finish impacting the component using the Femoral component impactor.
- For the cemented version, remove any excess cement taking care to limit the movement of the components while the cement is curing.

Option: Simulated gap balancing before femoral cuts

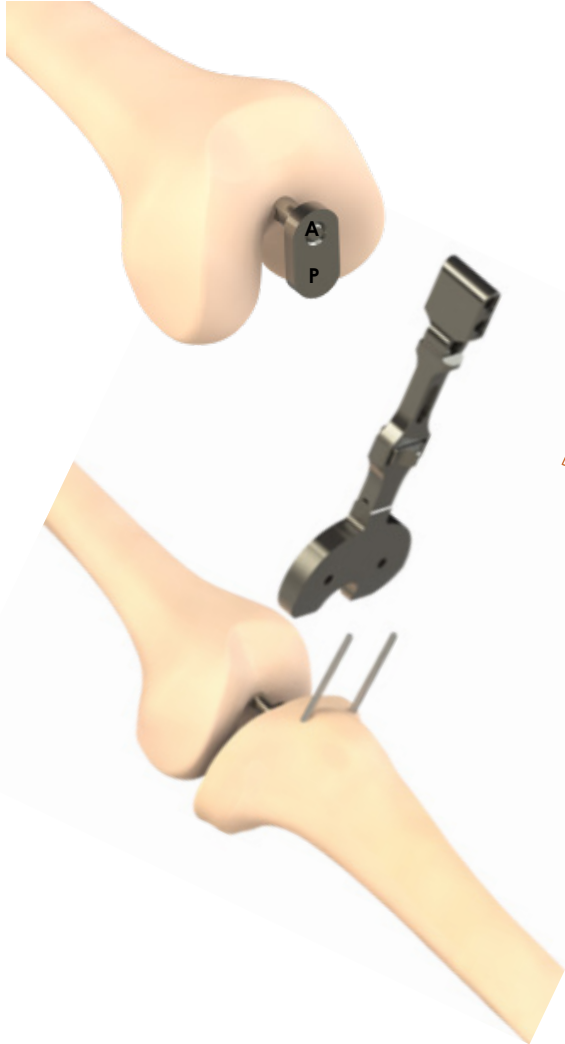

- Locate the entry point of the femoral medullary canal, and drill a hole into it using Intramedullary Drill Bit.
- Assemble the Impactor-extractor tip for intramedullary balancing simulator stem on the slaphammer).
- Use it to insert the Intramedullary Balancing Simulator Rod (or the Short intramedullary balancing simulator stem) while making sure the antero posterior (A/P) position is correct. Two Extension Spacer - Left (or Right) angle 5° (or 7°) Height 10 mm are available.

△ Before the cuts are made, the following actions can be performed with the knee extended:

- Simulate gap balancing with 5° or 7° valgus as if the femoral cuts had been made.
- Balance as needed.
- Validate the valgus barrel.

NOTE
This gap balancing simulator is optional.

- Place the Sizing Guide and the Valgus Alignment Guide 5° or 7° validated during the extension phase, on the intramedullary Balancing Simulator Rod..
- Same surgical technique as femoral step.

△ Before the cuts are made, the following can be performed with the knee flexed:

- Simulate gap balancing with 0°, 3° or 6° external rotation by using the Flexion Spacer - Right (or Left), angle 3° (or 6°) Height 7 mm.
- Once the rotation has been determined, fully tighten the front screw with the screwdriver

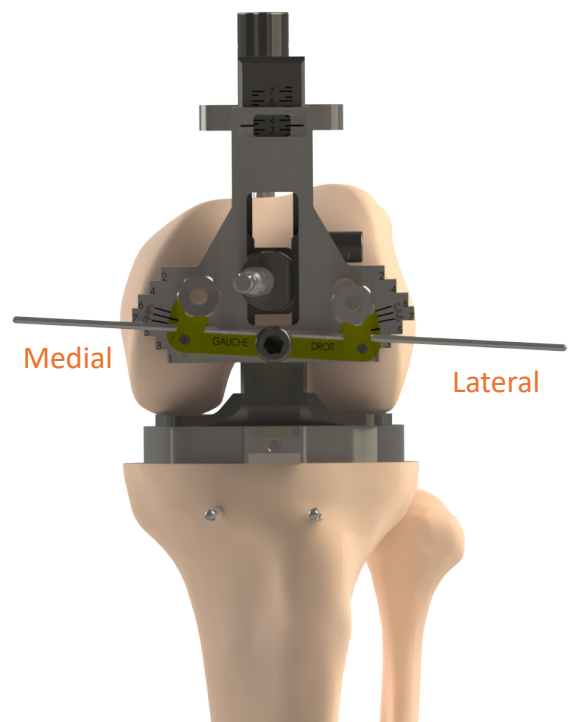

Option: Distal femoral pre-cut

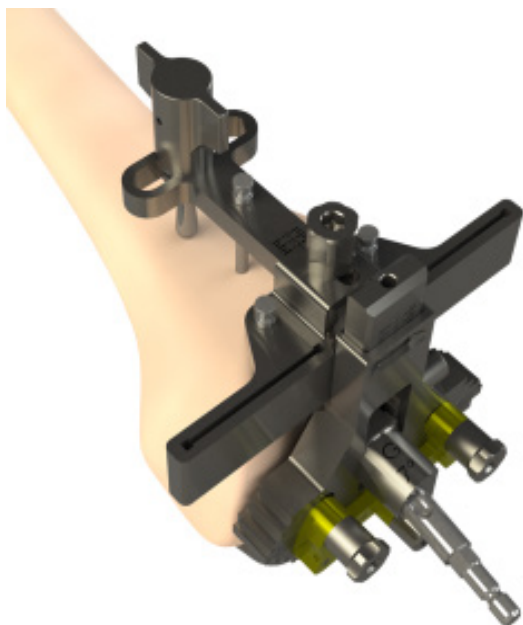

▷ For patients with a significant pre-operative flexion deformity, a 2 or 4 mm distal femoral pre-cut can be made:

- Secure the Additional Distal Resection Guide onto the front part of the Sizing Guide and transfer the chosen value.
- Insert two Headed Pin length 70 mm.
- Perform the distal femoral pre-cut.
- Once the cut has been made, set the Sizing Guide so it touches the distal condyles again.

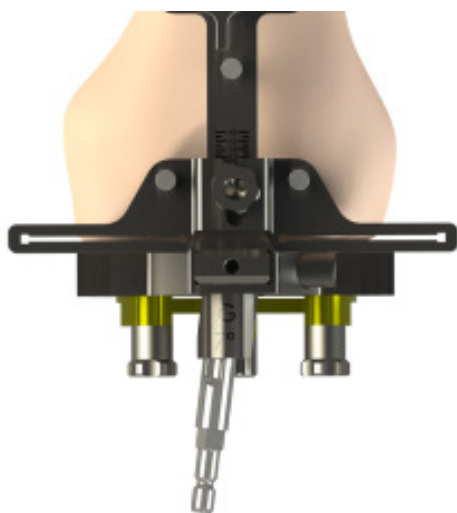

Option: MIS Femoral resection guides

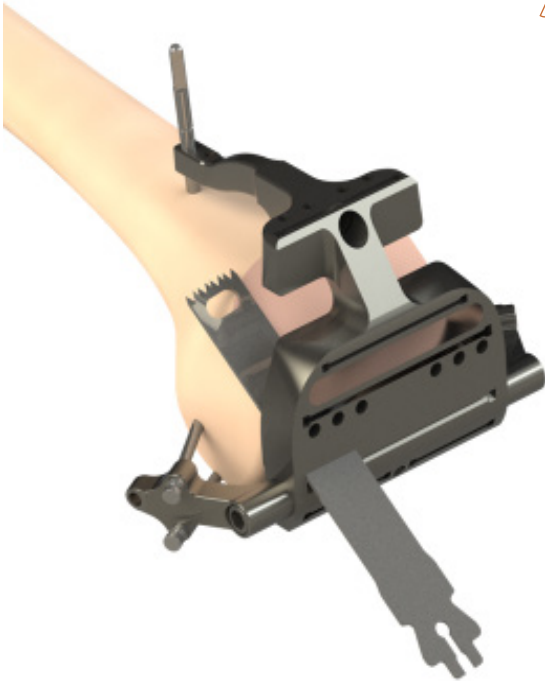

◊ IMA Femoral Resection Guides are available upon request to perform the femoral cuts:

- With the H5 screwdriver, secure the Femoral Resection Guide Stabilizer and at least one of the Bracket for MIS 5 in 1 revision femoral resection guide onto the 5-in-1 IMA Femoral Resection Guide of the selected size.
- Place the IMA Femoral resection guide on the Pin $\varnothing 4$ length 90 mm.
- Make sure the guide touches at least one of the distal condyles.
- To secure the assembly, put two Headed Pin - length 70 mm into the lateral Brackets for MIS and one Headed Pin into the anterior stabilizer. A smooth pin can be used in the notch instead of the anterior stabilizer.
- Remove the pins and perform the cuts:
 - Anterior
 - Posterior
 - Anterior chamfer
 - Posterior chamfer
 - Distal
- Remove the Headed Pins with the pin extractor, and then remove the resection guide.

NOTE

If desired, remove one pin and perform five half-cuts. Replace this pin and remove the other one to finish the cuts.

Option: Tibial augment, tibial extension stem and offset adapter



▷ Intramedullary tibial aiming:

- Based on the pre-operative planning, determine the entry point for the intramedullary (IM) canal and open the tibial canal with the Intramedullary Drill Bit.
- Gradually ream the medullary canal using the Reamers (Ø10, 12, 14,16) mounted on the T- Wrench.
- The graduated reamers are used to estimate the most appropriate extension stem length.
- Use progressively larger Reamers until contact is made with the bone cortex.
- Leave the last reamer used in place.

NOTE

If combined aiming is preferred, assemble the malleolar clamp with the extramedullary alignment rod and attach it around the ankle.

Set the rotation of the extramedullary alignment guide and its position in the sagittal plane before locking it into place with the H5 screwdriver

▷ Tibial instrumentation positioning:

- Assemble the Tibial slide bar and the Revision Tibial Resection Guide onto the Revision Tibial Bracket. Tighten the Wheel for Resection Guide.
- Put the entire unit onto the Reamer or Intramedullary Rod length 400 mm (or 250 mm) left in the tibia.
- Set the resection height with the stylus as follows:
 - On the healthy side: stylus positioned at 10 mm (10 mm cut relative to this reference).
 - On the worn side: stylus positioned at 0 mm (exit level of saw blade).
 - For other resection heights, use the 2 mm markings on the alignment rod.
 - Determine if a tibial augment is needed (resection guide place in the half-slots labelled 5/10/15).



Option: Tibial augment, tibial extension stem and offset adapter

Tibial cut:

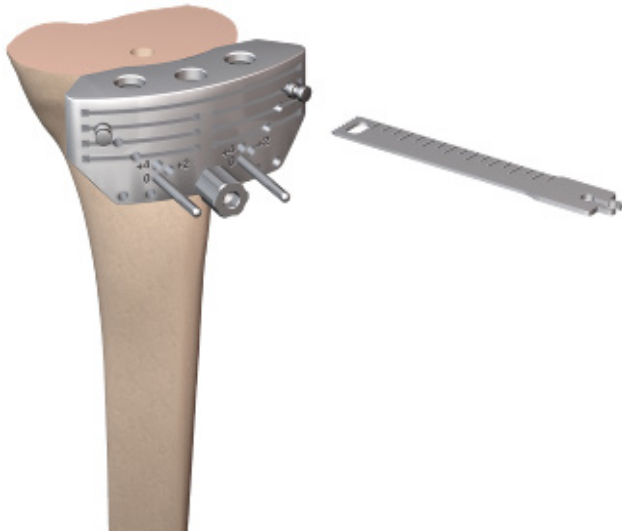

- Use the Universal quick release adaptor for pin or AO Pin Driver on a power engine to insert 2 Headless pin length 80 mm into the 0 landmarks of the Revision Tibial Resection Guide.
- Loosen the screw on the Revision Tibial Bracket with the H5 screwdriver.
- Use the saphammer to remove the intramedullary (and extramedullary) alignment rod.
- Set the resection guide against the bone.
- Stabilize the Revision Tibial Resection Guide with 3 Headed pin length 70 mm; the pin holes can be predrilled with the Long Drill bit, \varnothing 3.2, length 145 mm.
- Perform the medial and lateral tibial resection(s).
- Remove the headed pins with the pin extractor.
- Slide the resection guide off the pins, but make sure the pins stay in place in case recutting is required; if so, the +2 and +4 marks will be used.
- Make the cut, then assess the gaps and ligament tension with the knee flexed (Spacer Thickness 10mm) and extended (Spacer Thickness 18mm (see page 19)).

NOTE

Headless Pins have to be positioned closed to the main resection slot. In case of a resection for an augment, choose the holes just below for the Headless Pins.

NOTE

Use a medium saw blade (AMPLITUDE) to make the tibial cuts and those of the tibial augments (slots at 5/10/15 mm) if needed.

Option: Tibial augment, tibial extension stem and offset adapter

▷ Positioning of the trial baseplate:

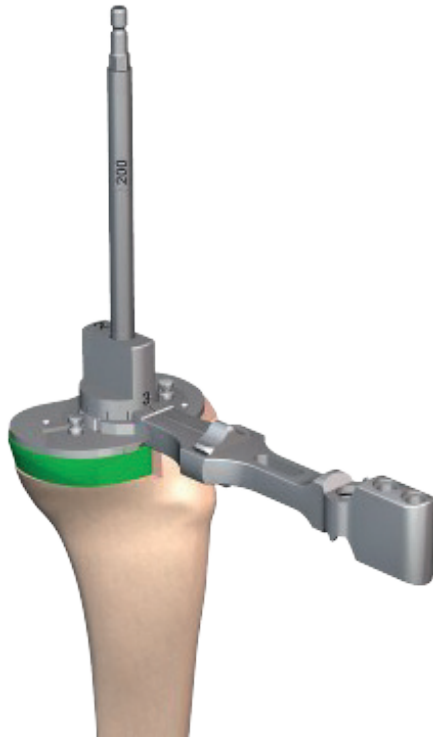

- Remove the two Headless pins that were left in the tibia (after the tibial cut is completed).
- Select the trial tibial baseplate that provides the best possible bone coverage.
- Reposition the Reamer selected during the tibial resection onto the T Wrench.
- Assemble the Offset Positioner for Trial Tibial Baseplate - 0 mm - onto the trial tibial baseplate.
- Insert these two components onto the reamer and on the tibial cut.
- If needed, a Trial Tibial Half-Wedge - Size 1/2 (or 3/4/5 or 6/7) thickness 5 mm or a Trial tibial half-wedge - Size 1/2 (or 3/4/5 or 6/7) thickness 10 mm (or 15mm) LAT.R./MED.L (or MED.R / LAT.L) of the same size of the baseplate can be placed between the Trial Tibial Baseplate and the resection done for the Augment.

- If the trial baseplate does not fully cover the tibial cut surface when it is centred on the reamer, use the 2, 4 or 6 mm Offset Positioner for Trial Tibial Baseplate instead.
- Turn the offset positioner until the trial tibial baseplate covers the cut surface completely.
- Make note of the connector size and its position using the graduations on the connector and the mark on the trial baseplate. This information will be used when the trial and final components are assembled.
- Secure the unit with 2 headed pins; the appropriate pin length 30, 50 or 70 mm depends on the thickness of any tibial augment that is used.
- Remove the reamer and offset positioner.
- Finalise the tibial preparation (see page 29).

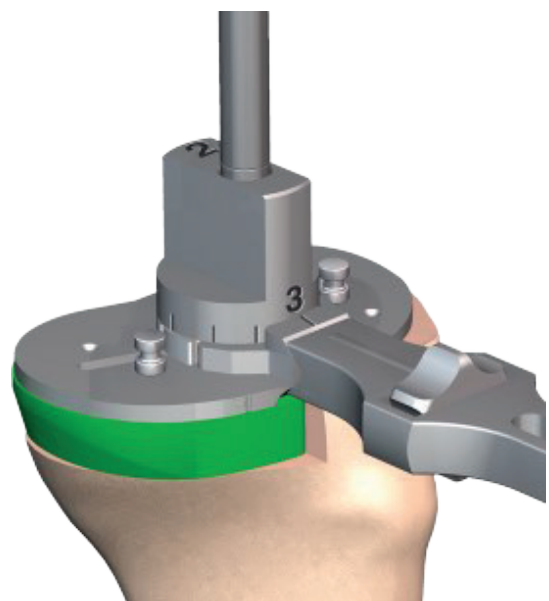

Option: Tibial augment, tibial extension stem and offset adapter



Tibial trials:

- Screw the Trial Extension Stem (length and diameter correspond to final reamer used) to the Trial Offset Connector corresponding to the selected tibial offset positioner. These components are assembled using the Wrench for Offset Connector and Tibial Stem Wrench.
- With the H5 screwdriver, tightly screw this unit to the Delta Wing for Tibial Trials while making sure the position of the Trial Offset Connector previously determined from the trial tibial baseplate is maintained.
- Impact the delta wing/connector (if used)/ extension stem unit through the tibial baseplate into the tibia until it stops.
- Secure the entire unit to the trial baseplate using the Thumb Knob to Connect Baseplate / Delta Wing. Tests can now be carried out in the same configuration as the final implants.

NOTE

If no connector is used, screw the trial extension stem directly into the delta wing for tibial trials.

Lengths	Diameters			
75	10	12	14	
100	10	12	14	16
150	10	12	14	16
200		12	14	

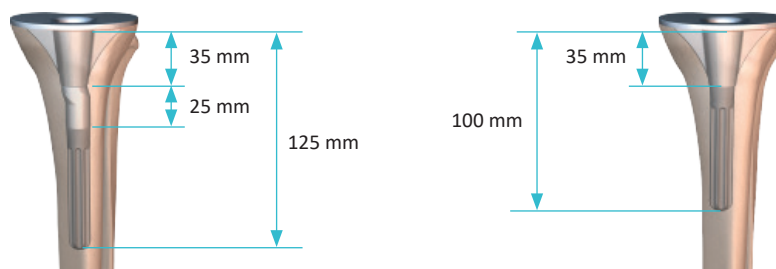

Examples with 100 mm long extension stem

Option: Tibial augment, tibial extension stem and offset adapter

▷ Assembly of definitive tibial implants:

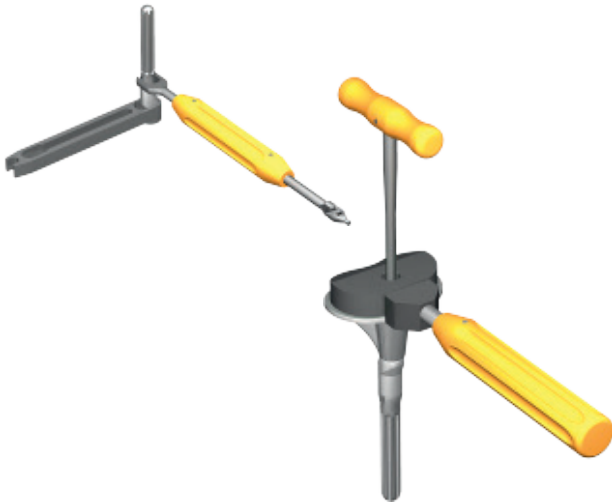

- Screw the tibial extension stem to the offset connector that corresponds to the validated tibial offset positioner. These components are assembled using the Wrench for Offset Connector, extension stem wrench and the H5 Screwdriver. If no offset connector is used, screw the extension stem directly into the tibial baseplate using the Tibial Stem Wrench and the H5 Screwdriver .
- Impact the whole unit into the tibial baseplate while matching the position determined during tibial preparation (laser markings can be found on the edge of the delta wing).
- Place the Tibial Impactor with Offset Connector into the female side of the baseplate taper.
- Finish impacting by firmly tightening the screw in the Tibial Impactor with Offset Connector with the H5 screwdriver.
- In case of modification of the adjustment of the Off-set Connector; the whole assembly can be disassembly with the Extractor for Offset Connector. Change the adjustment of the assembly and tighten the assembly.

▷ Placement of tibial implants:

- Carefully lavage the implantation site to clean it out.
- Prepare the bone cement and apply it to the tibial cut surface or under the tibial baseplate.
- If using a tibial augment, apply a thin layer of cement between the augment and tibial baseplate.
- Impact the final components into the tibia using the trial baseplate impactor and make sure the augment is perfectly positioned relative to the tibial baseplate and tibial cut.
- Tighten the tibial impactor with offset connector one last time before removing it completely
- Remove any excess cement.
- Place a tibial insert of the size corresponding to the femur and thickness validated during the trials.

Instrumentation

The 5-in-1 SCORE / SCORE AS conventional instrumentation* consists of 6 trays:

- Instrumentation set for SCORE Common Set
- Instrumentation set for SCORE Resection Tibial Set
- Instrumentation set for SCORE Tibial Trials Set
- Instrumentation set for SCORE 5-in-1 Femoral Resection
- Instrumentation set for SCORE Trial Femoral Set

And either of:

- Instrumentation set for SCORE Primary - Patella Resection Set (Conventional)
- Instrumentation set for SCORE patellar set - Reaming Patella Set

In addition:

- Instrumentation set for SCORE TKA MIS cutting guides
- Instrumentation set for Gap Balancing Simulation
- Instrumentation set for SCORE Tibial Revision
- Sterile large saw blades
- Sterile medium saw blades

*Not all devices presented in this Surgical Technique may be registered in your country. Please contact your Amplitude Sales Representative for availability.

Instrumentation

SCORE: Common set

2-02999130

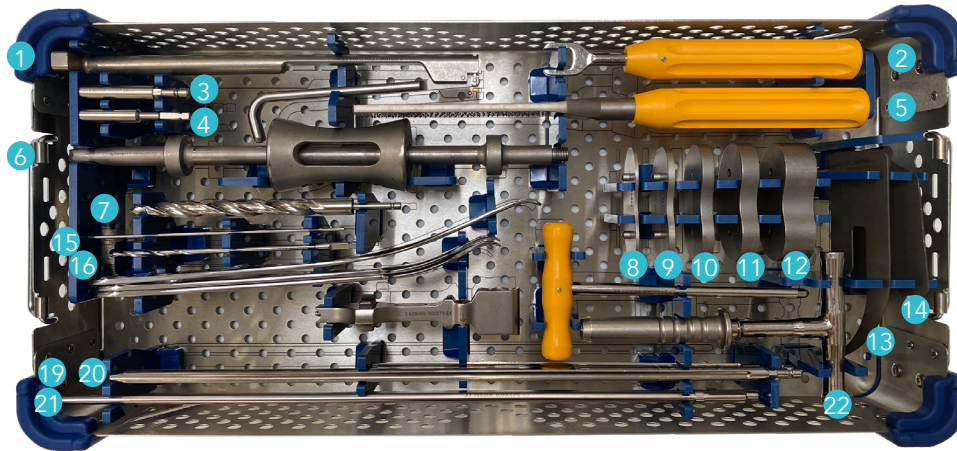

Item	Name	Product No.	Qty
1	Pin extractor	2-0201500	1
2	Tibial Stem Wrench	2-0205500	1
3	Universal quick release adaptor for pin	2-0201100	1
4	Pin Driver AO	2-0201200	1
5	Flat Rasp	2-0206800	1
6	Slaphammer	2-0206900	1
7	Intramedullary Drill Bit	2-0200100	1
8	Spacer thickness 2 mm for spacer	2-0207002	1
9	Spacer thickness 4 mm for spacer	2-0207004	1
10	Spacer Thickness 7 mm	2-0200707	1
11	Spacer Thickness 10 mm	2-0200710	1
12	Spacer Thickness 18 mm	2-0200718	1
13	Resection gauge	2-0204500	1
14	Alignment gauge	2-0206300	1
15	Alignment Pin Ø 2 Length 150 mm	2-0103000	2
16	Long Drill bit Ø 3.2 length 145 mm	2-0102400	1
17	Universal Handle	2-0216400	1
18	H5 Screwdriver	2-0200800	1
19	Intramedullary Rod length 250 mm	2-0200200	1
20	Intramedullary Rod length 400 mm	2-0200300	1
21	Extramedullary Alignment Rod	2-0200600	2
22	T Wrench	2-0200400	1

Instrumentation

SCORE: Resection tibial set

2-0299982

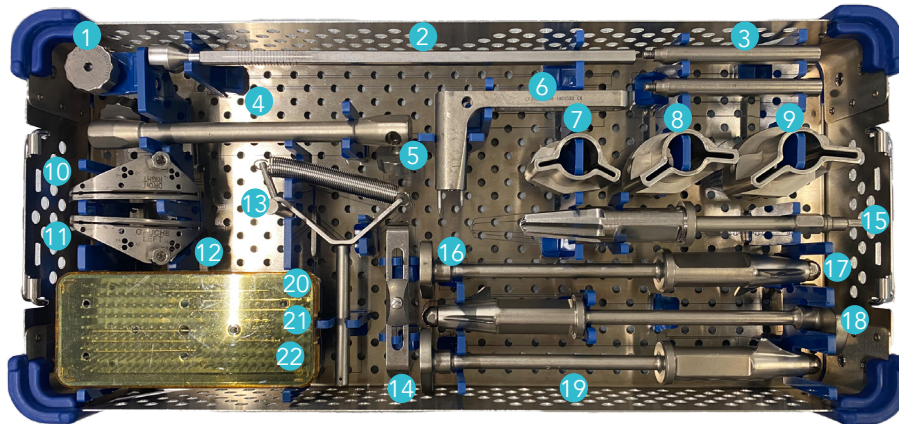

Item	Name	Product No.	Qty
1	Wheel for tibial bracket	2-0202100	1
2	Tibial slide bar	2-0201900	1
3	Removable handle for punch guide	2-0206200	2
4	Extramedullary alignment guide	2-0201700	1
5	Wheel for extramedullary Alignment column	2-0201800	2
6	Tibial bracket	2-0202000	1
7	Punch guide for tibial baseplate size 1/2	2-0202612	1
8	Punch guide for tibial baseplate size 3/4/5	2-0202635	1
9	Punch guide for tibial baseplate size 6/7	2-0202667	1
10	Tibial resection guide Left	2-0202300	1
11	Tibial resection guide Right	2-0202200	1
12	Wheel for resection guide	2-0203800	2
13	Malleolar clamp	2-0201600	1
14	Tibial stylus	2-0202400	1
15	Reamer for tibial extension stem	2-0202700	1
16	Punch for tibial extension stem - size 1/2	2-0202812	1
17	Standard trial stem	2-0208900	3
18	Punch for tibial extension stem - size 3/4/5	2-0202835	1
19	Punch for tibial extension stem - size 6/7	2-0202867	1
20	Headed pin length 30 mm	2-0201301	3
21	Headless pin length 80 mm	2-0201400	3
22	Headed pin length 70 mm	2-0201302	3



Instrumentation

SCORE: Tibial trial set

2-02999130

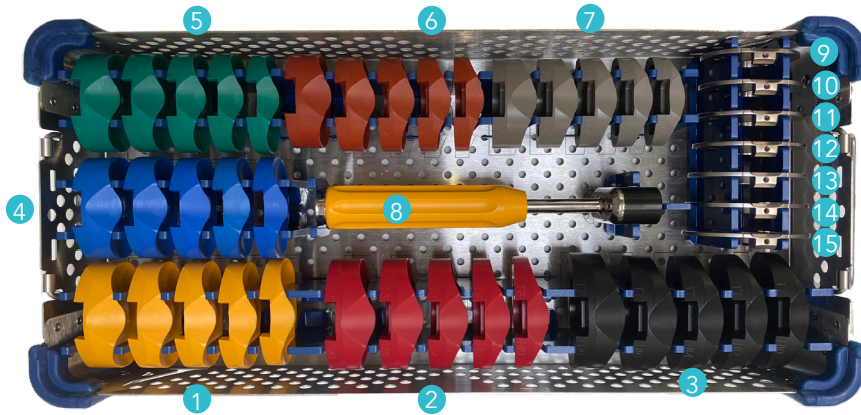

Item	Name	Product No.	Qty
1	Trial Insert Size 1 thickness 10 mm	2-0202911	1
1	Trial Insert Size 1 thickness 12 mm	2-0202921	1
1	Trial Insert Size 1 thickness 14 mm	2-0202931	1
1	Trial Insert Size 1 thickness 16 mm	2-0202941	1
1	Trial Insert Size 1 thickness 20 mm	2-0202951	1
2	Trial Insert Size 2 thickness 10 mm	2-0202912	1
2	Trial Insert Size 2 thickness 12 mm	2-0202922	1
2	Trial Insert Size 2 thickness 14 mm	2-0202932	1
2	Trial Insert Size 2 thickness 16 mm	2-0202942	1
2	Trial Insert Size 2 thickness 20 mm	2-0202952	1
3	Trial Insert Size 3 thickness 10 mm	2-0202913	1
3	Trial Insert Size 3 thickness 12 mm	2-0202923	1
3	Trial Insert Size 3 thickness 14 mm	2-0202933	1
3	Trial Insert Size 3 thickness 16 mm	2-0202943	1
3	Trial Insert Size 3 thickness 20 mm	2-0202953	1
4	Trial Insert Size 4 thickness 10 mm	2-0202914	1
4	Trial Insert Size 4 thickness 12 mm	2-0202924	1
4	Trial Insert Size 4 thickness 14 mm	2-0202934	1
4	Trial Insert Size 4 thickness 16 mm	2-0202944	1
4	Trial Insert Size 4 thickness 20 mm	2-0202954	1
5	Trial Insert Size 5 thickness 10 mm	2-0202915	1
5	Trial Insert Size 5 thickness 12 mm	2-0202925	1
5	Trial Insert Size 5 thickness 14 mm	2-0202935	1
5	Trial Insert Size 5 thickness 16 mm	2-0202945	1
5	Trial Insert Size 5 thickness 20 mm	2-0202955	1



Instrumentation

SCORE: Tibial trial set

2-02999130

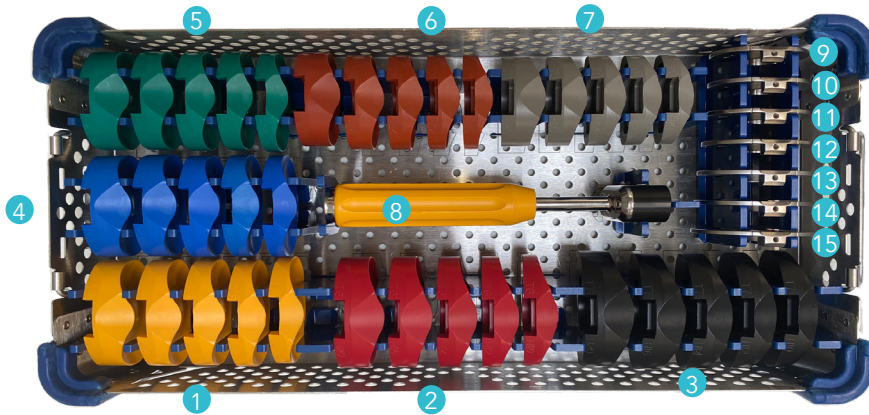

Item	Name	Product No.	Qty
6	Trial Insert Size 6 thickness 10 mm	2-0202916	1
6	Trial Insert Size 6 thickness 12 mm	2-0202926	1
6	Trial Insert Size 6 thickness 14 mm	2-0202936	1
6	Trial Insert Size 6 thickness 16 mm	2-0202946	1
6	Trial Insert Size 6 thickness 20 mm	2-0202956	1
7	Trial Insert Size 7 thickness 10 mm	2-0202917	1
7	Trial Insert Size 7 thickness 12 mm	2-0202927	1
7	Trial Insert Size 7 thickness 14 mm	2-0202937	1
7	Trial Insert Size 7 thickness 16 mm	2-0202947	1
7	Trial Insert Size 7 thickness 20 mm	2-0202957	1
8	Baseplate impactor	2-0203000	1
9 to 15	Trial Tibial Baseplate Size 1 to 7	2-0208601 to 2-0208607	1



Instrumentation

SCORE 5 in 1 Femoral resection

2-029944

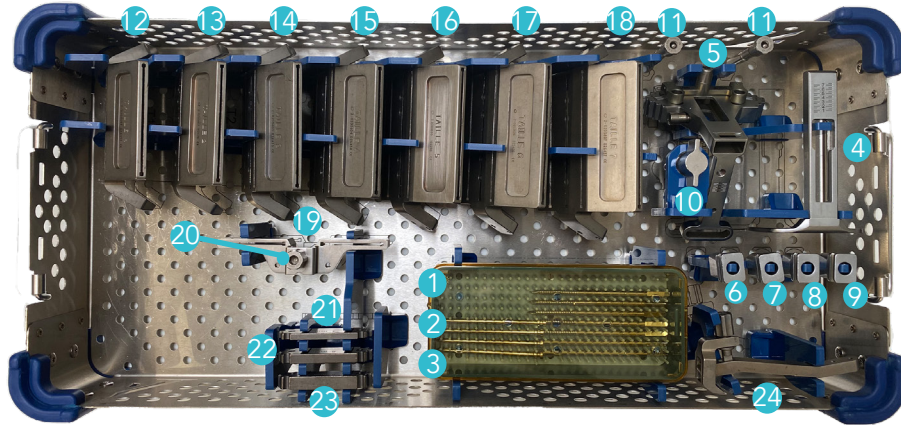

Item	Name	Product No.	Qty
1	Threaded Pin Ø4, length 90 mm	2-0200901	5
2	Smooth Pin Ø4, length 90 mm	2-0201000	2
3	Headed Pin length 70 mm	2-0201302	4
4	Posterior plate for sizing guide	2-0203100	1
5	Sizing Guide	2-0203200	1
6	Valgus Alignment Guide 3°	2-0203303	1
7	Valgus Alignment Guide 5°	2-0203305	1
8	Valgus Alignment Guide 7°	2-0203307	1
9	Valgus Alignment Guide 9°	2-0203309	1
10	Anterior Femoral Stylus	2-0203400	1
11	Drill Guide for Ø4 Pin	2-0203500	2
12 to 18	Femoral resection guide size 1 to 7	2-0203601 to 2-0203607	1
19	Additional Distal Resection Guide	2-0203700	1
20	Wheel for Resection Guide	2-0203800	1
21	Femoral Recutting Wedge - 4 mm	2-0206004	1
22	Femoral Recutting Wedge - 6 mm	2-0206006	1
23	Femoral Recutting Wedge - 8 mm	2-0206008	1
24	Femoral Resection Guide Stabilizer	2-0209900	1

Instrumentation

SCORE: Femoral trial set

2-02999130

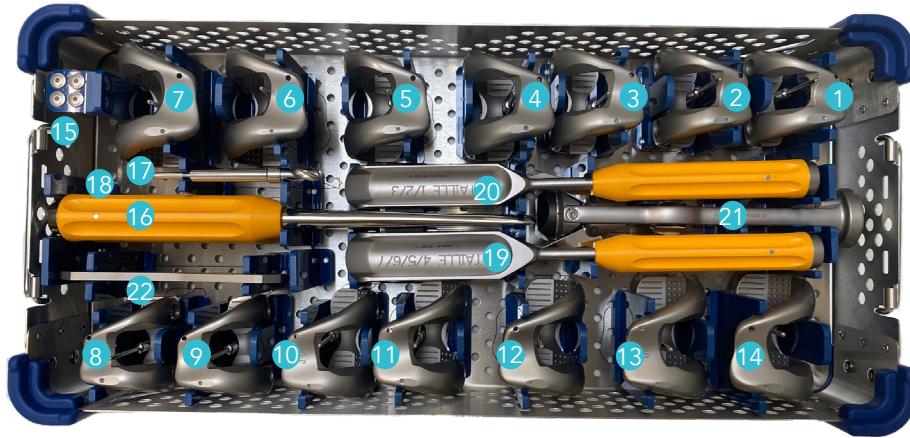

Item	Name	Product No.	Qty
1 to 7	SCORE Trial Femoral Component - Right Size 1 to 7	2-0208501 to 2-0208507	1
8 to 14	SCORE Trial Femoral Component - Right Size 1 to 7	2-0208511 to 2-0208517	1
15	Trial peg for trial femoral component	2-0206600	4
16	Cutting gauge	2-0206500	1
17	Drill for peg holes	2-0204000	1
18	Femoral component impactor	2-0204300	1
19	Femoral rasp Size 1/2/3	2-0204113	1
20	Femoral rasp Size 4/5/6/7	2-0204147	1
21	Femoral condyle holder	2-0204400	1
22	Intercondylar control gauge	2-0215200	1



Instrumentation

SCORE Primary - Patellar resection set (Conventional)

2-02999132

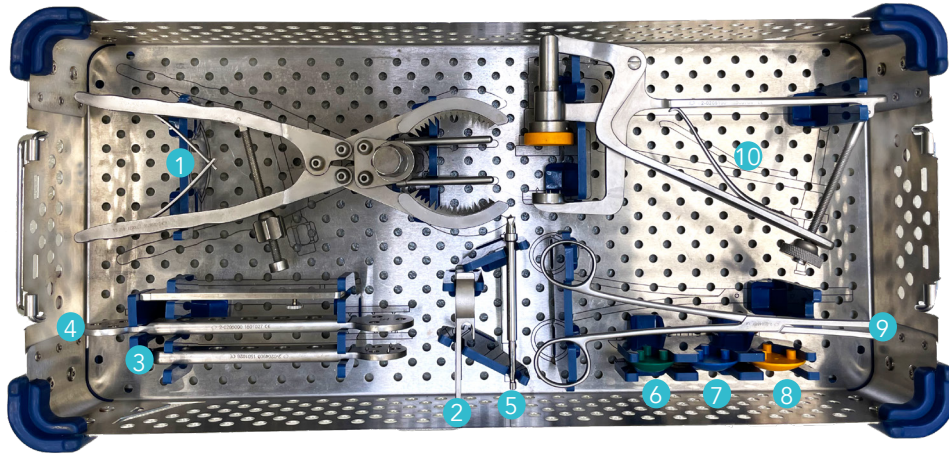

Item	Name	Product No.	Qty
1	Patellar Resection Clamp	2-0206700	1
2	Patellar resection gauge	2-0208400	1
3	Patellar Drilling Guide Ø 30	2-0204900	1
4	Patellar Drilling Guide Ø 33 and Ø 36	2-0205000	1
5	Drill Bit for resurfacing patella	2-0205100	1
6	Trial resurfacing patella Ø 30	2-0205330	1
7	Trial resurfacing patella Ø 33	2-0205333	1
8	Trial resurfacing patella Ø 36	2-0205336	1
9	Clamp for Locking Ring	2-0104600	1
10	Patellar Impaction Clamp	2-0206100	1

Instrumentation

SCORE Patella set - Patella reaming

2-0299917

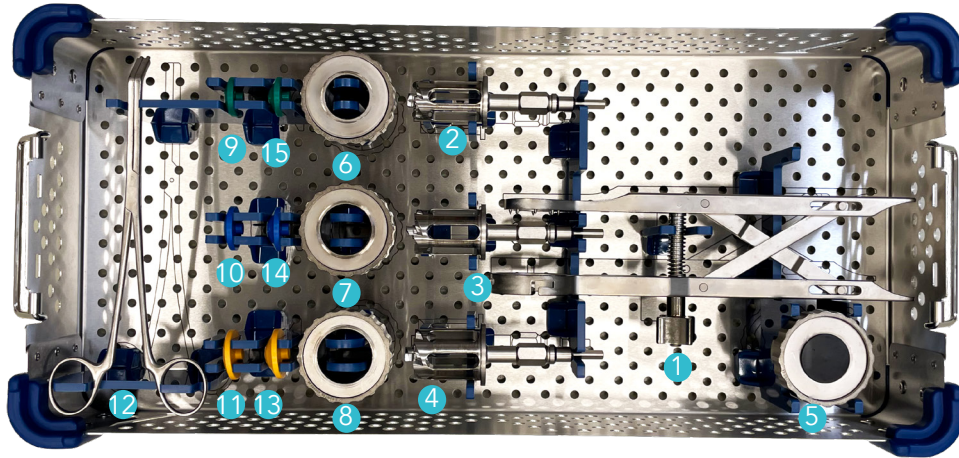

Item	Name	Product No.	Qty
1	Patellar reamer Clamp	2-0216600	1
2	Reamer for inset cementless patella Ø 23	2-0216523	1
3	Reamer for inset cementless patella Ø 26	2-0216526	1
4	Reamer for inset cementless patella Ø 29	2-0216529	1
5	Patellar Reamer Impaction Clamp	2-0216800	1
6	Patella Reamer Surfacing Guides Ø 23	2-0216723	1
7	Patella Reamer Surfacing Guides Ø 26	2-0216726	1
8	Patella Reamer Surfacing Guides Ø 29	2-0216729	1
9	Trial inset patellar - cemented Ø 23—Plastic	2-0205223	1
10	Trial inset patellar - cemented Ø 26—Plastic	2-0205226	1
11	Trial inset patellar - cemented Ø 29—Plastic	2-0205229	1
12	Clamp for Locking Ring	2-0104600	1
13	Trial inset patellar - cementless Ø 29 —Plastic	2-0216929	1
14	Trial inset patellar - cementless Ø 26—Plastic	2-0216926	1
15	Trial inset patellar - cementless Ø 23—Plastic	2-0216923	1



Instrumentation

SCORE: TKA MIS cutting guides

2-0299945

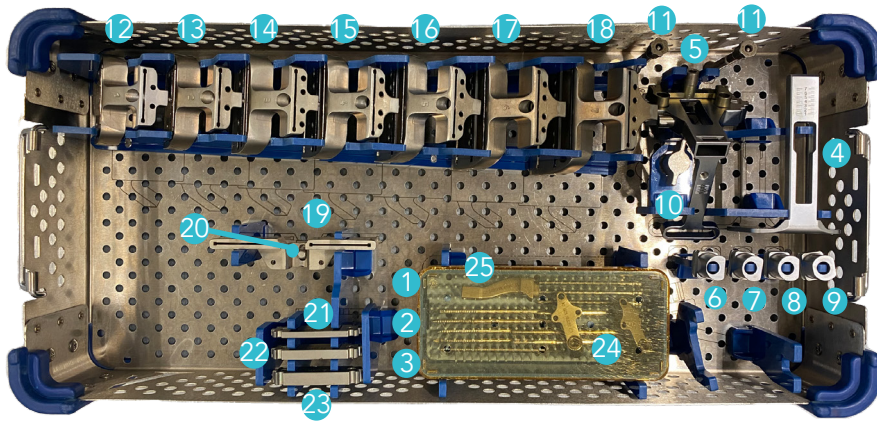

Item	Name	Product No.	Qty
1	Threaded Pin \varnothing 4 length 90 mm	2-0200901	5
2	Smooth Pin \varnothing 4 length 90 mm	2-0201000	2
3	Headed Pin - length 70 mm	2-0201302	4
4	Posterior Plate for Sizing Guide	2-0203100	1
5	Sizing Guide	2-0203200	1
6	Valgus Alignment Guide 3°	2-0203303	1
7	Valgus Alignment Guide 5°	2-0203305	1
8	Valgus Alignment Guide 7°	2-0203307	1
9	Valgus Alignment Guide 9°	2-0203309	1
10	Anterior Femoral Stylus	2-0203400	1
11	Drill Guide for \varnothing 4 Pin	2-0203500	2
12 to 18	IMA Femoral Resection Guide Size 1 to 7	2-0217701 to 2-0217707	1
19	Additional Distal Resection Guide	2-0203700	1
20	Wheel for Resection Guide	2-0203800	1
21	Femoral Recutting Wedge - 4 mm	2-0206004	1
22	Femoral Recutting Wedge - 6 mm	2-0206006	1
23	Femoral Recutting Wedge - 8 mm	2-0206008	1
24	Bracket for MIS 5 in 1 revision femoral resection guide	2-0217900	2
25	Femoral Resection Guide Stabilizer	2-0217800	1

Instrumentation

SCORE: Gap balancing simulator

2-0299904

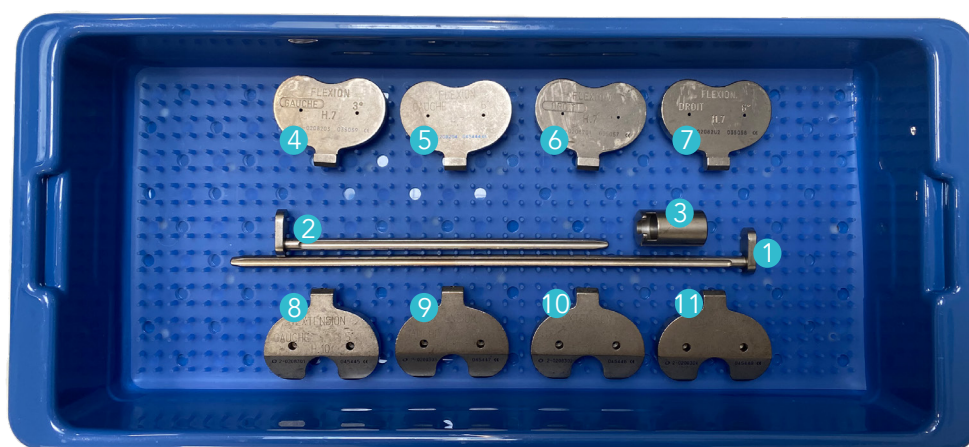

Item	Name	Product No.	Qty
1	Intramedullary Balancing Simulator Rod	2-0208000	1
2	Short intramedullary balancing simulator stem	2-0209400	1
3	Impactor-extractor tip for intramedullary balancing simulator stem	2-0208100	1
4	Flexion Spacer - Right, angle 3° Height 7 mm	2-0208201	1
5	Flexion Spacer - Right, angle 6° Height 7 mm	2-0208202	1
6	Flexion Spacer - Left, angle 3° Height 7 mm	2-0208203	1
7	Flexion Spacer - Left, angle 6° Height 7 mm	2-0208204	1
8	Extension Spacer - Left, angle 5° Height 10 mm	2-0208301	1
9	Extension Spacer - Right, angle 5° Height 10 mm	2-0208302	1
10	Extension Spacer - Left, angle 7° Height 10 mm	2-0208303	1
11	Extension Spacer - Right, angle 7° Height 10 mm	2-0208304	1



Instrumentation

SCORE: Tibial revision

2-029912

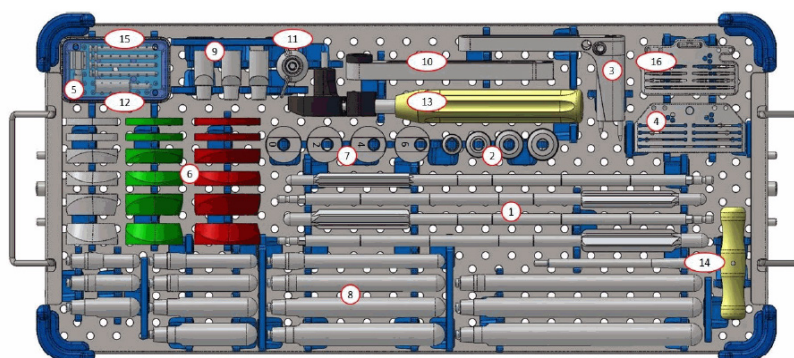

Item	Name	Product No.	Qty
1	Reamer Ø10	2-0210510	1
1	Reamer Ø12	2-0210512	1
1	Reamer Ø14	2-0210514	1
1	Reamer Ø16	2-0210516	1
2	Sleeve 10/15*	2-0211400	1
2	Sleeve 12/19*	2-0211401	1
2	Sleeve 14/21*	2-0211402	1
2	Sleeve 16/23*	2-0211403	1
3	Revision Tibial Bracket	2-0211000	1
4	Revision Tibial Resection Guide	2-0210600	1
5	Wheel for Resection Guide	2-0203800	1
6	Trial Tibial Half-Wedge - Size 1/2 thickness 5 mm	2-0210311	2
6	Trial tibial half-wedge - Size 1/2 thickness 10 mm MED.R / LAT.L	2-0210321	1
6	Trial tibial half-wedge - Size 1/2 thickness 15 mm MED.R / LAT.L	2-0210331	1
6	Trial tibial half-wedge - Size 1/2 thickness 10 mm LAT.R./ MED.L	2-0210341	1
6	Trial tibial half-wedge - Size 1/2 thickness 15 mm LAT.R./ MED.L	2-0210351	1
6	Trial Tibial Half-Wedge - Size 3/4/5 thickness 5 mm	2-0210313	2
6	Trial tibial half-wedge - Size 3/4/5 thickness 10 mm MED.R / LAT.L	2-0210323	1
6	Trial tibial half-wedge - Size 3/4/5 thickness 15 mm MED.R / LAT.L	2-0210333	1
6	Trial tibial half-wedge - Size 3/4/5 thickness 10 mm LAT.R./ MED.L	2-0210343	1
6	Trial tibial half-wedge - Size 3/4/5 thickness 15 mm LAT.R./ MED.L	2-0210353	1
6	Trial tibial half-wedge - Size 6/7 thickness 5 mm	2-0210316	2
6	Trial tibial half-wedge - Size 6/7 thickness 10 mm MED.R / LAT.L	2-0210326	1
6	Trial tibial half-wedge - Size 6/7 thickness 15 mm MED.R / LAT.L	2-0210336	1
6	Trial tibial half-wedge - Size 6/7 thickness 10 mm LAT.R./ MED.L	2-0210346	1



Instrumentation

SCORE: Tibial revision

2-029912

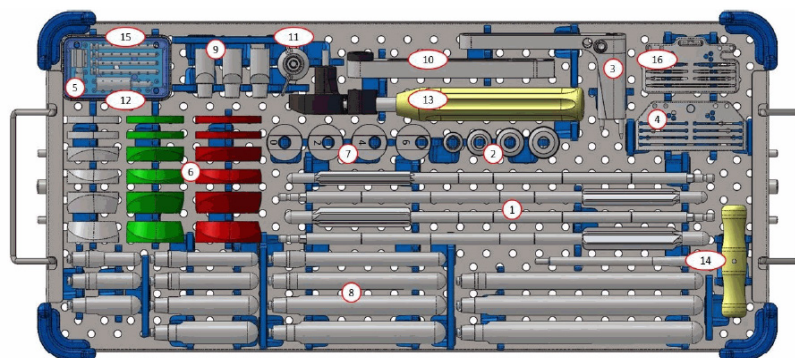

Rep	Designation	Référence	Qté
6	Trial tibial half-wedge - Size 6/7 thickness 15 mm LAT.R./MED.L	2-0210356	1
7	Offset Positioner for Trial Tibial Baseplate - 0 mm	2-0213300	1
7	Offset Positioner for Trial Tibial Baseplate - 2 mm	2-0213302	1
7	Offset Positioner for Trial Tibial Baseplate - 4 mm	2-0213304	1
7	Offset Positioner for Trial Tibial Baseplate - 6 mm	2-0213306	1
8	Trial extension stem Ø 10 length 75 mm	2-0209021	1
8	Trial extension stem Ø 12 length 75 mm	2-0209022	1
8	Trial extension stem Ø 14 length 75 mm	2-0209023	1
8	Trial extension stem Ø 10 length 100 mm	2-0209013	1
8	Trial extension stem Ø 12 length 100 mm	2-0209001	1
8	Trial extension stem Ø 14 length 100 mm	2-0209004	1
8	Trial extension stem Ø 16 length 100 mm	2-0209007	1
8	Trial extension stem Ø 10 length 150 mm	2-0209014	1
8	Trial extension stem Ø 12 length 150 mm	2-0209002	1
8	Trial extension stem Ø 14 length 150 mm	2-0209005	1
8	Trial extension stem Ø 16 length 150 mm	2-0209008	1
8	Trial extension stem Ø 12 length 200 mm	2-0209003	1
8	Trial extension stem Ø 14 length 200 mm	2-0209006	1
8	Trial extension stem Ø 16 length 200 mm	2-0209009	1
9	Trial Offset Connector 2 mm	2-0214102	1
9	Trial Offset Connector 4 mm	2-0214104	1
9	Trial Offset Connector 6 mm	2-0214106	1
10	Wrench for Offset Connector	2-0213500	1
11	Delta Wing for Tibial Trials	2-0213401	1
12	Thumb Knob to Connect Baseplate / Delta Wing	2-0215400	1
13	Tibial Impactor with Offset Connector	2-0213700	1
14	Extractor for Offset Connector	2-0214300	1
15	Headed Pin length 50 mm	2-0201303	4
16	4T Tibial Resection Guide - Revision	2-0253300	1



Instrumentation

Large saw blades

SYNTHES AO / SODEM large Sawblade

Sterile Product No. 2-0227901

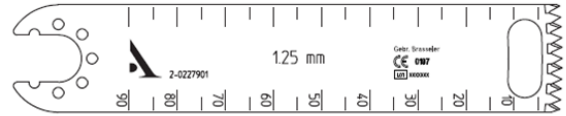

STRYKER large Sawblade

Sterile Product No. 2-0227902

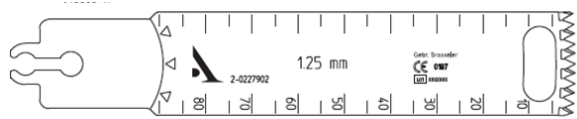

ZIMMER / HALL / LINVATEC large Sawblade

Sterile Product No. 2-0227903



Medium saw blades

SYNTHES AO / SODEM medium Sawblade

Sterile Product No. 2-0228001

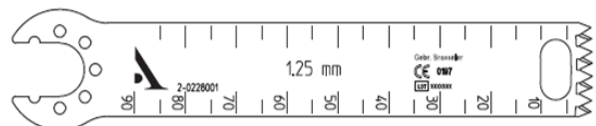

STRYKER medium Sawblade

Sterile Product No. 2-0228002

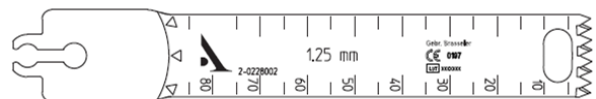

ZIMMER / HALL / LINVATEC medium Sawblade

Sterile Product No. 2-0228003



Not all devices presented in this Surgical Technique may be distributed in your country. Please contact your Amplitude Sales Representative for availability.



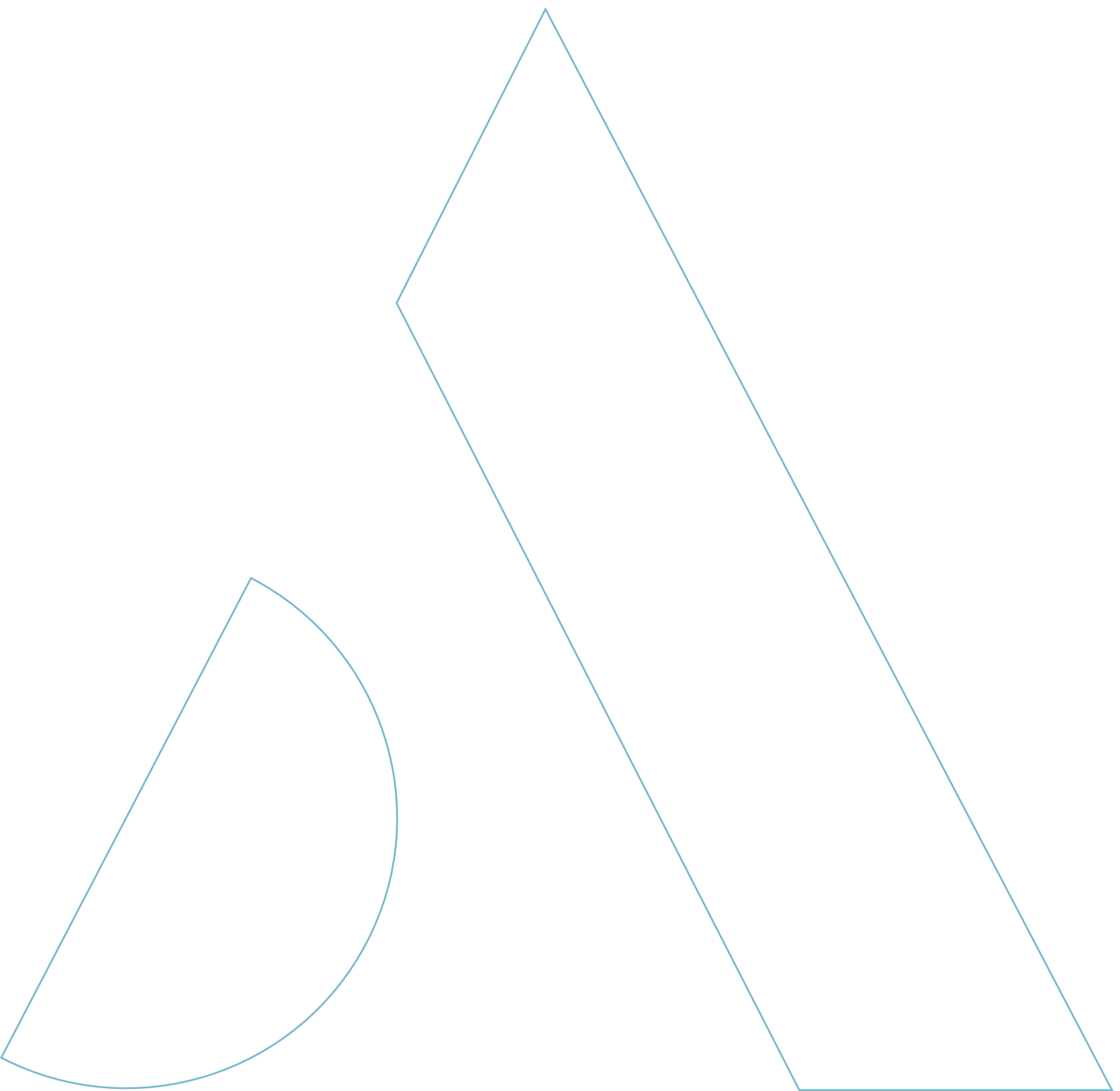



Customer Service – France:

Porte du Grand Lyon,
01700 Neyron – France
Tél.: **+33 (0)4 37 85 19 19**
Fax: +33 (0)4 37 85 19 18
E-mail: amplitude@amplitude-ortho.com

Customer Service – Export:

11, cours Jacques Offenbach,
ZA Mozart 2,
26000 Valence – France
Tél.: **+33 (0)4 75 41 87 41**
Fax: +33 (0)4 75 41 87 42

www.amplitude-ortho.com

Reference: TO.G.008/EN/C